



DIESEL[®]
L I V I N G

WITH
FOSCARINI

PRICE-LIST
2017 /EUROPE



-
PRICE-LIST
TECHNICAL BOOK
2017 EUROPE

Valid from 1st January 2017



WITH
FOSCARINI





Diesel Living

DIESEL LIVING WITH FOSCARINI

From rock to pop, from casual to vintage and from graphics to art. This is a completely new collection of lamps that speaks a multitude of languages, tells different stories and expresses an unmistakable style: the Diesel lifestyle. Ironic, unconventional, fun, fiery and creative. A way of being and of dressing that also becomes a way of furnishing: Diesel Living with Foscarini.

foscarini.com



LEGENDA

FOSCARINI



1. **ENEC**
The label ENEC (Electrical Certification concerning European Standard) is a voluntary label granted by third organizations.
It certifies that a product complies to the EN 60598 standards and has been designed and manufactured by companies with an approved UNI EN ISO 9001 quality control system.



2. **CE**
Declares that the manufacturer produces light fittings which comply with the requirements of the EN 60598.



3. **Classe I**
Class I luminaire: it's necessary to connect the device to the yellow/green protective conductor (earthing).



4. **Classe II**
Light fittings whose safety is guaranteed only by the double and/or reinforced insulation of all parts, with no earth.



5. Luminaire suitable for installation on normally inflammable surfaces. **CE**
Declares that the manufacturer produces light fittings which comply with the requirements of the EN 60598.

6. **IP protection degree**
IP20: protected against the penetration of solid objects greater than 12 mm and non-protected against liquids.

7. The energy efficiency classes for light appliances set out by EU regulation no. 874/2012 are calculated on the basis of the Energy Efficiency Index (EEI) and range between A++ (maximum efficiency) and E (minimum efficiency).



8. **CSQ-IQNET**
The CSQ-IQNET label is valid all over the world. It certifies that FOSCARINI runs a quality management system which complies with the UNI EN ISO 9001:2008 standard, to guarantee a high quality level for what concerns project, development, production and distribution of its products.



9. **CSQ ECO**
This label is valid all over the world. It certifies that FOSCARINI runs an environmental management system which complies with the UNI EN ISO 14001:2004 standard in order to guarantee company's commitment to continual improvement of its environmental performances.



The dimmer could cause flickering of the light in case of use of a bulb with a lower wattage than the minimum indicated. It is not possible to guarantee the proper functioning of the dimmer with LED retrofit bulbs or compact fluo bulbs with integrated power supply.

Spare parts:

Lampshades, dimmer, protection glasses etc. that can be ordered as spare parts.

Accessories:

Multiply canopies, kits decentralization that are not included but can be ordered if necessary.



LED

It marks the models with integrated LED included in the lamp, which is the result of Foscarini designing and engineering.

EXCERPT FROM THE SALES CONDITIONS

1. Our prices are net ex works.
2. The prices include: carton packaging, transformers for low tensions. Prices do not include bulbs, if not differently stated.
3. The prices here contained refer to materials complying with the technical standards of the market this price list is meant for. Any request for material complying with other standards shall be quoted separately.
4. Goods are carefully inspected and accurately packed before shipment, Foscarini Spa therefore declines any liability for transport damages.
5. The goods are dispatched at the buyer's risk, even if sent free domicile.
6. Claims must be notified by registered mail addressed to our head offices within 3 days from receipt of the goods.
7. Any litigation falls within cognisance of Venice / Italy Law-Court.
8. Dimensions and colours indicated have a tolerance due to the characteristic handwork of materials.
9. This price list can be subject to alteration without any notice.
10. Products images and configurations may vary from price book, catalogues and website from the actual merchandise, including but not limited to cords, cables, color, price, dimension, descriptions, details, dimmer.
11. Foscarini reserves the property of the goods until full payment of the same.
12. Prices are expressed in Euro.
13. This price list replaces any previous one. This price list replaces any previous one.

INTERACTIVE TOOLS

Diesel Lamps app



Diesel Lamps an app designed for all design enthusiasts who wish to customise their surroundings with the unmistakable personality of Diesel with Foscarini models.

With captivating and emotional graphics and extremely user-friendly it allows users to insert lamps in rooms and settings which are caught on camera each time or picked from an archive of pictures. Available on the Apple Store and Play Store the Diesel Lamps app is a very effective tool that is extremely simple to use.

Social media

Foscarini is present on all the main social networks with systems and languages suited to each individual channel and type of user:

- [Facebook](#) to create and maintain public relations, communicate news and projects, share news, images and films;
- [Instagram](#) to view projects and stimulate users to create images with Diesel with Foscarini models.
- [Twitter](#) publicise events, initiatives, news and links in brief, high impact messages;
- [Pinterest](#) to share images of Diesel with Foscarini models and initiatives, subdividing them into theme boards;
- [LinkedIn](#) to create and maintain relationships with sector operators and share professional contents



foscarini.com



Packed with content, the foscarini.com website keeps you up-to-date on our products, events and cultural initiatives at all times. The Video Stories section gives you the chance to find out about the concept and development of some of the most important Foscarini products. Information on the company, detailed technical data sheets for all models, assembly instructions, 2D and 3D designs as well as photometric curves can all be downloaded.

myFoscarini



With the same spirit that provides new ideas in lighting design, Foscarini creates its own more efficient programs for customer and partner communication, for instance, [myFoscarini](#), a proprietary it platform, an absolutely innovative, highly flexible and transparent tool providing customers with complete information and full range of functions. With just a few clicks in myFoscarini you can:









- check the availability of lamps and the shipping date
- Enter your orders, reserving lamps directly from Foscarini's central system
- track your order status





- consult sale conditions;
- download admin documents such as transport documents and invoices;
- prepare a quotation;
- download: images, logos, PDF and excel price lists assembly instructions, certifications and energy labels.





And all this 7 days a week, 24 hours a day.







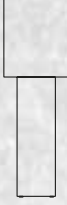

If you haven't registered yet request your password from Foscarini Customer Care.







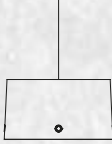

									
TAVOLO	Drumbox 10	Duii 11	Duii mini 12	Fork 13	Fork mini 14	Fork maxi 14	Glas 15	Glass Drop 16	Hexx 17



					
	Metafisica 18	Metal Glass 19	Pett 20	Pipe 21	Soft Power 22

					
TERRA	Drumbox 23	Fork 24	Pipe 25	Pylon 26	Rock 27

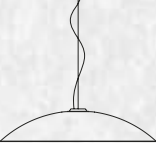
									
SOSPENSIONE	Bell 28	Crash 28	Cage Mic 29	Cage 30	Drumbox 35	Fork 32	Fork XL 34	Gask 36	Glas 37

								
	Glass Drop 38	Metal Glass 39	Mysterio 40	Pylon 41	Rock 42	Smash 43 NEW	Tool 44	White Noise 45 LED

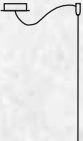
							
SOFFITTO	Mysterio 46	PARETE	Duii mini 47	Fork 48	Gask 49 NEW	Mysterio 50	Smash 51 NEW

			
ACCESSORI	Rosone multiplo 52	Kit Decentramento 56	Packing 58

DRUMBOX

Diesel Creative Team 2011

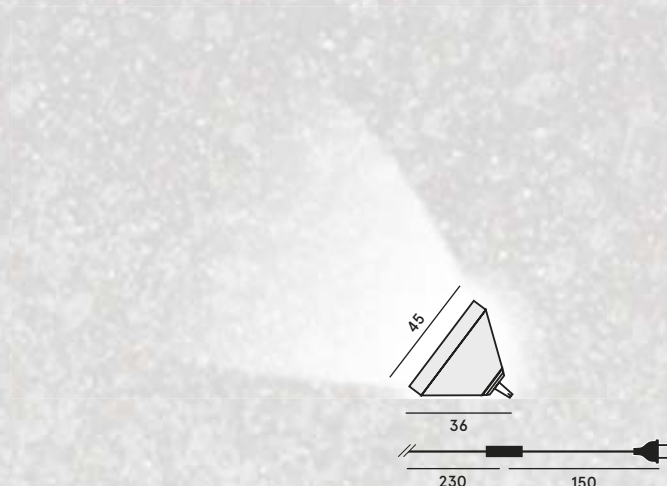

LIGHT BULBS (NOT INCLUDED)
LED retrofit or FLUO 1x20W E27

WEIGHT
net kg 2,60

MATERIALS
Linen coupled with techno polymer, polyester, thermoplastic material and coated steel

□ ▽ CE IP 20

> specifications p. 59

	COLOURS	ENERGY CLASS	CODE	VAT EXCLUDED
Drumbox	Bianco	A ⁺ , A	LI2031 10 E	500,00

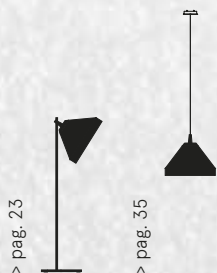

DUII

Diesel Creative Team 2011

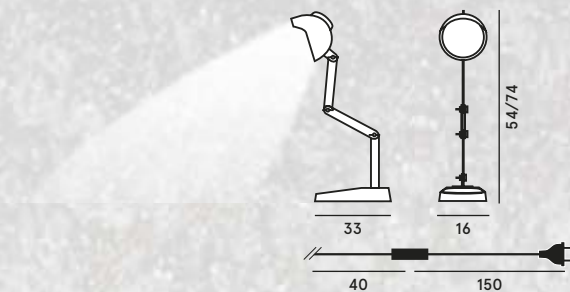

LIGHT BULBS (NOT INCLUDED)
LED retrofit 1x10W R7s (78mm)

> specifications p. 59

WEIGHT
net kg 4,10

MATERIALS
Pressed glass,
aluminium, steel and
laquered metal



adjustable arm and lampshade

	COLOURS	ENERGY CLASS	CODE	VAT EXCLUDED
Duii	Grigio	A ⁺ , A	LI1811 25 E1	463,00
	Giallo		LI1811 50 E1	

> pag. 12



> pag. 47



Giallo



Grigio

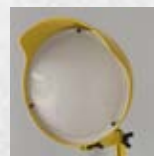

DUII MINI

Diesel Creative Team 2012

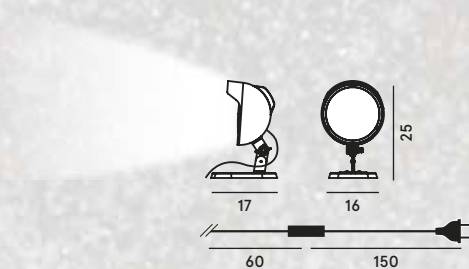

LIGHT BULBS (NOT INCLUDED)
LED retrofit 1x10W R7s (78mm)

WEIGHT
net kg 1,40

MATERIALS
Pressed glass,
aluminium, steel and
laquered metal

CERTIFICATIONS

> specifications p. 59

adjustable lampshade,
with personalized packaging

	COLOURS	ENERGY CLASS	CODE	VAT EXCLUDED
Duii mini	Grigio	A ⁺ , A	LI1812 25 E1	295,00
	Giallo		LI1812 50 E1	

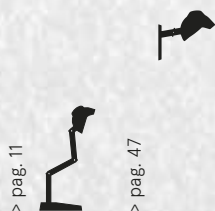

FORK

Diesel Creative Team 2009

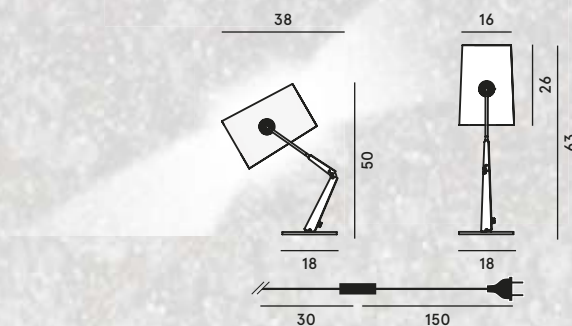

LIGHT BULBS (NOT INCLUDED)
halogen or LED retrofit
1x48W R7s (78mm)

with dimmer included minimum Halo bulb
output 40W*,
with LED retrofit bulbs use dimmer
only at full power

> specifications p. 59

adjustable lampshade

WEIGHT
net kg 2,40

MATERIALS
Dyed linen,
polycarbonate and
coated steel



	COLOURS	ENERGY CLASS	CODE	VAT EXCLUDED
Fork with dimmer	Marrone/Grigio	A ⁺ , A, C	LI0411 25 E	684,00
	Marrone/Avorio		LI0411 50 E	
	Avorio/Grigio		LI0412 25 E	
	Avorio/Avorio		LI0412 50 E	
Fork on/off	Marrone/Grigio	A ⁺ , A, C	LI0411S 25 E	663,00
	Marrone/Avorio		LI0411S 50 E	
	Avorio/Grigio		LI0412S 25 E	
	Avorio/Avorio		LI0412S 50 E	
SPARE PARTS				
Lampshade Fork	Grigio		LI04DP 25 E	227,00
	Avorio		LI04DP 50 E	
Protection glass			PIREX98/2	8,00
Dimmer			LTD FD TR/I	29,00



FORK MINI / MAXI

Diesel Creative Team 2014

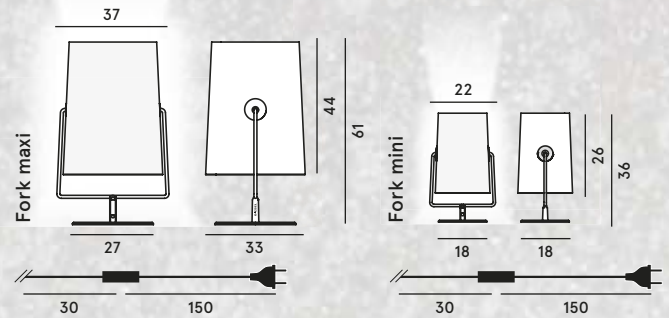

LIGHT BULBS (NOT INCLUDED)

Fork maxi

halogen or LED retrofit 1x120W R7s (118mm)
dimmer included minimum bulb output 40W*,
with LED retrofit bulbs use dimmer only at full power

Fork mini

halogen or LED retrofit 1x48W R7s (78mm)
dimmer included minimum bulb output 40W*,
with LED retrofit bulbs use dimmer only at full power

> specifications p. 59

adjustable lampshade

WEIGHT

Fork maxi
net kg 3,80

Fork mini

net kg 2,40

MATERIALS

Dyed linen,
polycarbonate and
coated steel



	COLOURS	ENERGY CLASS	CODE	VAT EXCLUDED
Fork maxi	Marrone/Grigio	A ⁺ , A, C	LI0413 25 E	702,00
	Marrone/Avorio		LI0413 50 E	
	Avorio/Grigio		LI0414 25 E	
	Avorio/Avorio		LI0414 50 E	
Fork mini	Marrone/Grigio	A ⁺ , A, C	LI0415 25 E	517,00
	Marrone/Avorio		LI0415 50 E	
	Avorio/Grigio		LI0416 25 E	
	Avorio/Avorio		LI0416 50 E	
SPARE PARTS				
Lampshade Fork maxi	Grigio		LI04DG 25 E	356,00
	Avorio		LI04DG 50 E	
Lampshade Fork mini	Grigio		LI04DP 25 E	227,00
	Avorio		LI04DP 50 E	
Protection glass maxi			PIREX138/2S4I	20,00
Protection glass mini			PIREX98/2	8,00
Dimmer			LTD FD TR/I	29,00

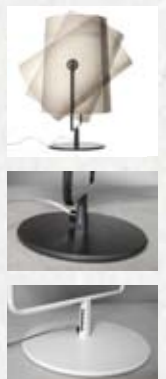
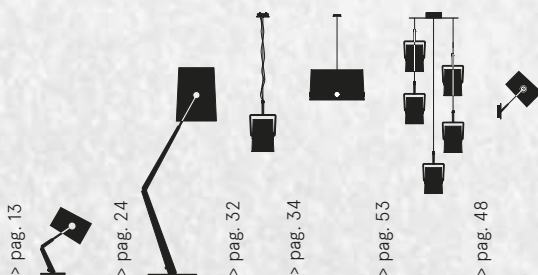

GLAS

Diesel Creative Team 2009

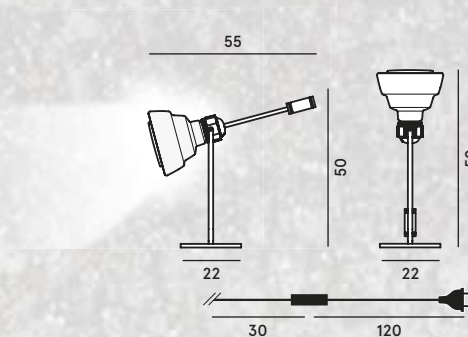
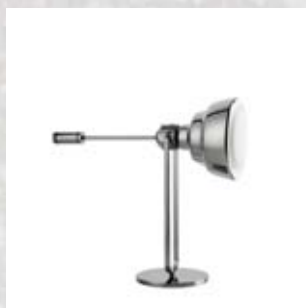

LIGHT BULBS (NOT INCLUDED)
LED retrofit or FLUO 1x21W E27

> specifications p. 59

WEIGHT
net kg 6,50

MATERIALS
Metallized or sandblasted blown glass, thermoplastic material and nickel-plated steel

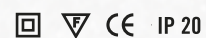

	COLOURS	ENERGY CLASS	CODE	VAT EXCLUDED
Glas	Cromo*	A ⁺ , A	LI0101 78 E	625,00
	Bianco *		LI0101 10 E	514,00

SPARE PARTS

Glass Glas	Cromo	LI01VP 78 E	246,00
	Bianco	LI01VP 10 E	135,00

* limited stock available



Cromo



Bianco



GLASS DROP

Diesel Creative Team 2014

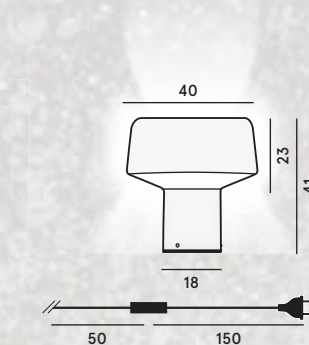
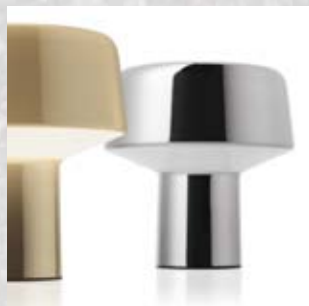

LIGHT BULBS (NOT INCLUDED)
halogen or dimmable LED retrofit
1x150W E27

dimmer included
minimum Halo bulb output 40W*

> specifications p. 59

WEIGHT
net kg 7,90

MATERIALS
Metallized blown
glass and varnished
steel

CERTIFICATIONS



	COLOURS	ENERGY CLASS	CODE	VAT EXCLUDED
Glass Drop	Cromo	A ⁺ , A, C	LI3011 78 E	799,00
SPARE PARTS				
Glass Glass Drop	Cromo		LI30VT 78 E	628,00
Dimmer			RLTD 1003	29,00

> pag. 38

> pag. 53

Cromo

on

off

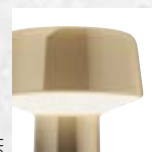

HEXX

Diesel Creative Team 2014

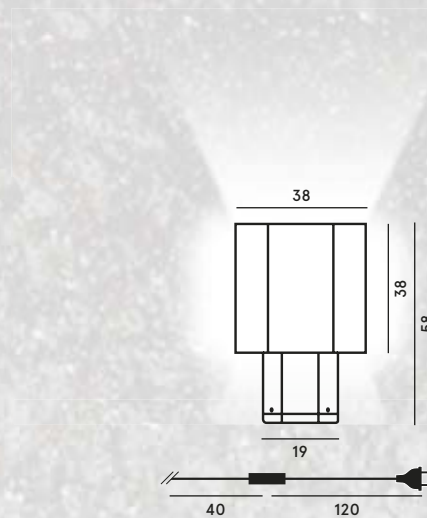

LIGHT BULBS (NOT INCLUDED)

halogen 1x105W E27 +
halogen 1x100W E27 PAR or
LED retrofit 1x20W E27 + 1x12W E27 PAR

> specifications p. 59

WEIGHT
net kg 6,30

MATERIALS
Varnished steel and
silkscreen-printed
glass



double switch

	COLOURS	ENERGY CLASS	CODE	VAT EXCLUDED
Hexx	Verde	A ⁺ , A, C	LI3411 40 E	515,00
	Nero		LI3411 20 E	



METAFISICA

Diesel Creative Team 2014

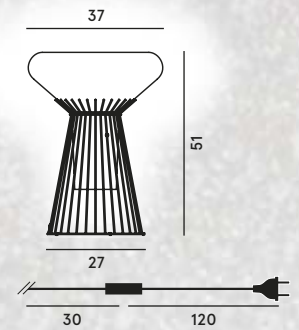

LIGHT BULBS (NOT INCLUDED)
halogen or dimmable LED retrofit
1x150W E27

WEIGHT
net kg 5,50

MATERIALS
Blown glass and
varnished steel



dimmer included
minimum Halo bulb output 40W*

> specifications p. 59

	COLOURS	ENERGY CLASS	CODE	VAT EXCLUDED
Metafisica	Avorio	A ⁺ , A, C	LI3311 50 E	653,00
SPARE PARTS				
Glass Metafisica	Avorio		LI33VT 50 E	282,00
Dimmer			LTD FD TR/I	29,00



METAL GLASS

Diesel Creative Team 2012

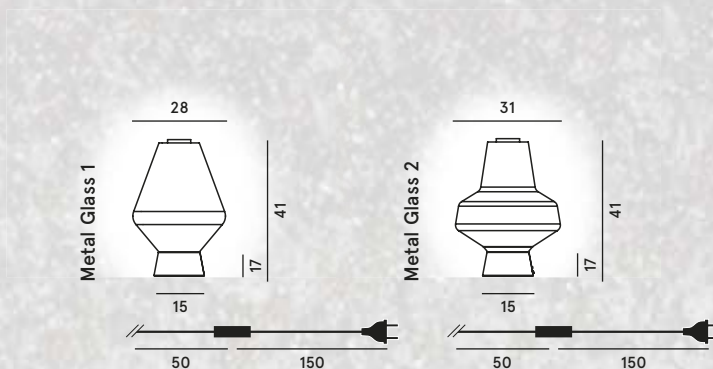

LIGHT BULBS (NOT INCLUDED)

halogen or dimmable LED retrofit
1x150W E27

dimmer included
minimum Halo bulb output 40W*

> specifications p. 59

WEIGHT

Metal Glass 1
net kg 3,80

Metal Glass 2
net kg 4,70

MATERIALS

Blown glass, Pyrex
and acid-etched
steel



	COLOURS	ENERGY CLASS	CODE	VAT EXCLUDED
Metal Glass 1	Grigio	A ⁺ , A, C	LI2211 25E	593,00
	Ambra		LI2211 52E	
Metal Glass 2	Grigio	A ⁺ , A, C	LI2212 25E	593,00
	Verde		LI2212 40E	
SPARE PARTS				
Glass Metal Glass 1	Grigio		LI22V1 25E	236,00
	Ambra		LI22V1 52E	
Glass Metal Glass 2	Grigio		LI22V2 25E	236,00
	Verde		LI22V2 40E	
Dimmer			LTD FD N/I	29,00

> pag. 39

> pag. 53

1 grigio



1 ambra



2 grigio



2 verde



PETT

Diesel Creative Team 2011

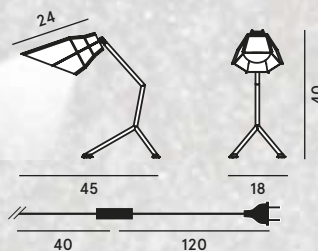

LIGHT BULBS (NOT INCLUDED)
LED retrofit or FLUO 1x12W E14

WEIGHT
net kg 0,70

MATERIALS
Batch-dyed ABS,
coated steel and
thermoplastic
elastomer



> specifications p. 59

adjustable lampshade on the vertical axis
with personalized packaging

	COLOURS	ENERGY CLASS	CODE	VAT EXCLUDED
Pett	Bianco	A ⁺ , A	LI0811 10 E	236,00
	Nero		LI0811 20 E	
	Azzurro		LI0811 30 E	
	Fucsia		LI0811 65 E	

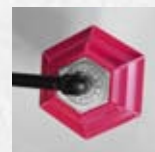

PIPE

Diesel Creative Team 2011

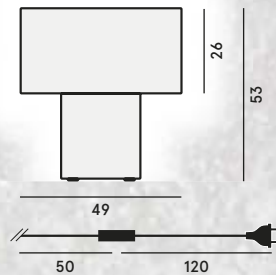

LIGHT BULBS (NOT INCLUDED)
LED retrofit or FLUO 1x20W E27

WEIGHT
net kg 3,30

MATERIALS
Dyed natural linen,
PVC and coated
metal



> specifications p. 59

	COLOURS	ENERGY CLASS	CODE	VAT EXCLUDED
Pipe	Bianco	A ⁺ , A	LI1411 10 E	782,00
	Nero		LI1411 20 E	1.026,00
	Mesh		LI1411 21 E	1.026,00

> pag. 25



Bianco



Nero



Mesh



Bianco



Nero

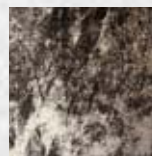

Mesh

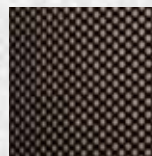

SOFT POWER

Diesel Creative Team 2012



Soft Power grande

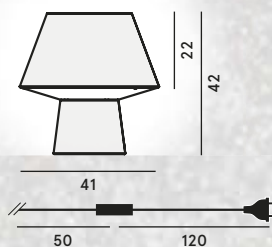

Soft Power piccola

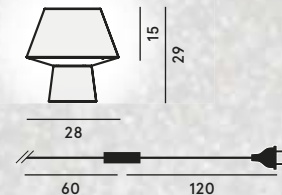

LIGHT BULBS (NOT INCLUDED)

Soft Power grande
halogen 1x77W E27 or
LED retrofit or FLUO 1x20W E27

Soft Power piccola
halogen 1x46W E14 or
LED retrofit or FLUO 1x12W E14

> specifications p. 59

WEIGHT

Soft Power grande
net kg 1,00

Soft Power piccola
net kg 0,60

MATERIALS

Printed cotton,
polycarbonate and
coated metal



	COLOURS	ENERGY CLASS	CODE	VAT EXCLUDED
Soft Power grande	Nero	A ⁺ , A, B, C	LI2311 20 E	395,00
Soft Power piccola	Nero		LI2312 20 E	336,00
	Azzurro*		LI2312 33 E	

* limited stock available



DRUMBOX

Diesel Creative Team 2011

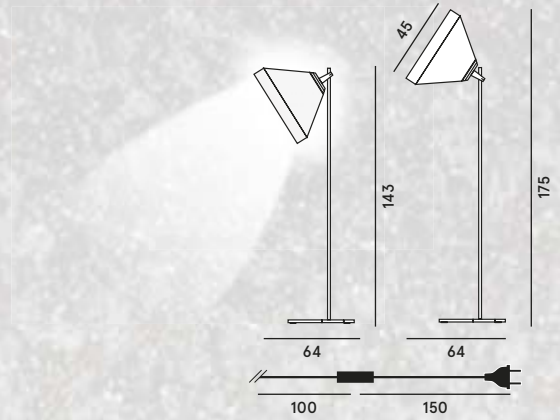

LIGHT BULBS (NOT INCLUDED)
LED retrofit or FLUO 1x20W E27

WEIGHT
net kg 9,80

MATERIALS
Linen coupled with
techno polymer,
polyester,
thermoplastic
material and coated
steel



> specifications p. 59

	COLOURS	ENERGY CLASS	CODE	VAT EXCLUDED
Drumbox	Bianco	A ⁺ , A	LI2032 10 E	799,00

> pag. 10



> pag. 35



Bianco

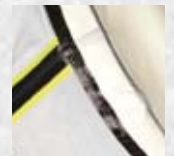
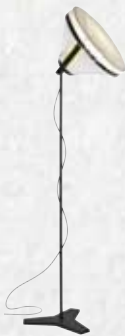

FORK

Diesel Creative Team 2009

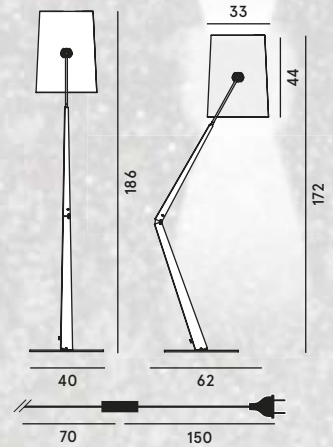

LIGHT BULBS (NOT INCLUDED)

halogen or LED retrofit
1x120W R7s (118mm)
with dimmer included minimum Halo bulb
output 60W*,
with LED retrofit bulbs use dimmer
only at full power

> specifications p. 59

WEIGHT

net kg 11,50

MATERIALS

Dyed linen,
polycarbonate and
coated steel



adjustable lampshade

	COLOURS	ENERGY CLASS	CODE	VAT EXCLUDED
Fork with dimmer	Marrone/Grigio	A+,A, C	LI0431 25 E	975,00
	Marrone/ Avorio		LI0431 50 E	
	Avorio/Grigio		LI0432 25 E	
	Avorio/Avorio		LI0432 50 E	
Fork on/off	Marrone/Grigio	A+,A, C	LI0431S 25 E	950,00
	Marrone/ Avorio		LI0431S 50 E	
	Avorio/Grigio		LI0432S 25 E	
	Avorio/Avorio		LI0432S 50 E	
SPARE PARTS				
Lampshade Fork	Grigio		LI04DG 25 E	356,00
	Avorio		LI04DG 50 E	
Protection glass			PIREX138/2S4I	20,00
Dimmer			LTD RONDO T/I	42,00



PIPE

Diesel Creative Team 2011

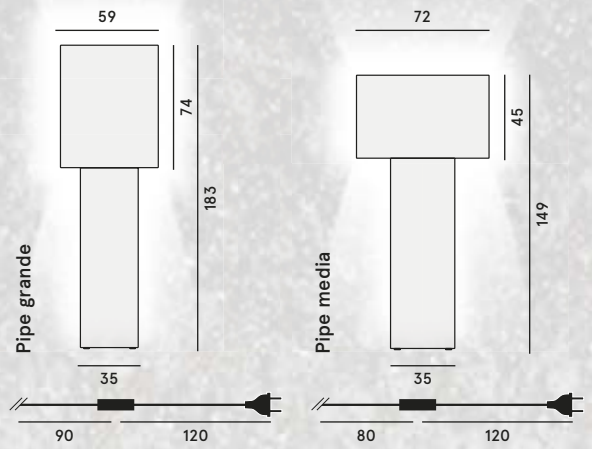

LIGHT BULBS (NOT INCLUDED)
halogen or dimmable LED retrofit
2x150W E27

dimmer included
minimum Halo bulb output 100W*

> specifications p. 59

WEIGHT
Pipe grande
net kg 8,50

Pipe media
net kg 9,00

MATERIALS
Dyed natural linen,
PVC and coated
metal



double switch

	COLOURS	ENERGY CLASS	CODE	VAT EXCLUDED
Pipe grande	Bianco	A+, A, C	LI1431 10 E	1.648,00
	Nero		LI1431 20 E	1.958,00
	Mesh		LI1431 21 E	1.958,00
Pipe media	Bianco		LI1432 10 E	1.614,00
	Nero		LI1432 20 E	1.984,00
	Mesh		LI1432 21 E	1.984,00
SPARE PARTS				
Dimmer			LTD RONDO4F/I	41,00

> pag. 21



Grande bianco



Grande nero



Grande mesh



Media bianco



Media nero



Media mesh



Bianco



Nero



Mesh



PYLON

Diesel Creative Team 2014

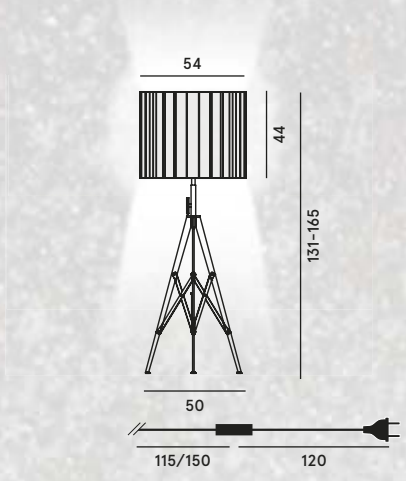

LIGHT BULBS (NOT INCLUDED)
halogen or dimmable LED retrofit
1x116W E27

WEIGHT
net kg 8,80

MATERIALS
Dyed linen, PVC and
varnished steel



dimmer included
minimum Halo bulb output 100W*

> specifications p. 59

extendable stem

	COLOURS	ENERGY CLASS	CODE	VAT EXCLUDED
Pylon	Nero/Avorio	A ⁺ , A, C	LI3731 50 E	1.194,00
SPARE PARTS				
Lampshade Pylon	Avorio		LI37D 50 E	563,00
Dimmer			LTD RONDO T/I	42,00

> pag. 41



ROCK

Diesel Creative Team 2009

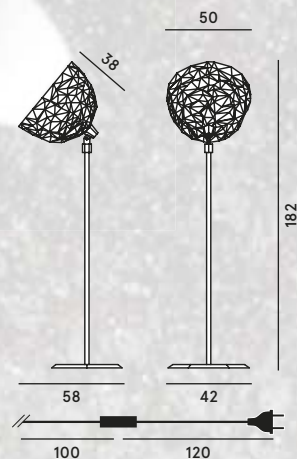

LIGHT BULBS (NOT INCLUDED)
LED retrofit or FLUO 1x23W E27

Recommended white globe bulb
Ø 12 cm

> specifications p. 59

WEIGHT
net kg 9,50

MATERIALS
Moulded coated ABS
+ polycarbonate,
lacquered metal and
nylon

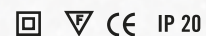

adjustable lampshade on the vertical axis

	COLOURS	ENERGY CLASS	CODE	VAT EXCLUDED
Rock	Bianco	A+, A	LI0503 10 E	753,00
	Nero		LI0503 52 E	
	Oro		LI0503 50 E	
SPARE PARTS				
Lampshade Rock	Bianco		LI05FD 10 E	355,00
	Nero		LI05FD 52 E	
	Oro		LI05FD 50 E	

> pag. 42



Bianco



Nero



Oro

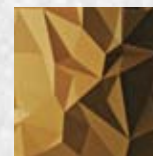
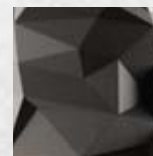
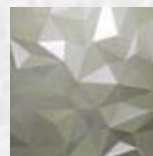
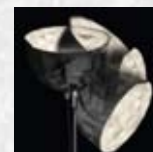

BELL - CRASH

Diesel Creative Team 2014

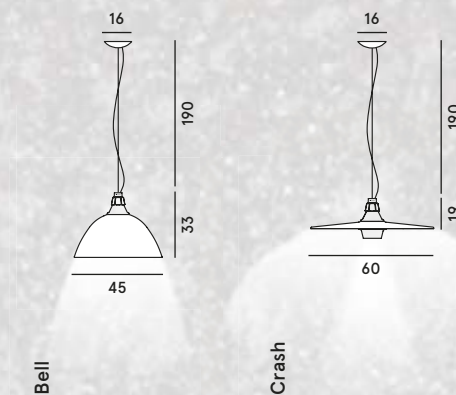

LIGHT BULBS (NOT INCLUDED)
halogen 1x57W E27
LED retrofit or FLUO 1x16W E27

> specifications p. 59

WEIGHT
Bell
net kg 2,20

Crash
net kg 2,20

MATERIALS
Blown sandblasted
glass and varnished
aluminium



	COLOURS	ENERGY CLASS	CODE	VAT EXCLUDED
Bell	Alluminio	A ⁺ , A, C	LI2872 77 E	522,00
	Bronzo		LI2872 55 E	
Crash	Alluminio	A ⁺ , A, C	LI2871 77 E	522,00
	Bronzo		LI2871 55 E	
Bell h. 5 m	Alluminio	A ⁺ , A, C	LI2872 77 E5	540,00
	Bronzo		LI2872 55 E5	
Crash h. 5 m	Alluminio	A ⁺ , A, C	LI2871 77 E5	540,00
	Bronzo		LI2871 55 E5	
SPARE PARTS				
Lampshade Bell	Alluminio		LI28D2 77 E	252,00
	Bronzo		LI28D2 55 E	
Lampshade Crash	Alluminio		LI28D1 77 E	252,00
	Bronzo		LI28D1 55 E	
Diffuser glass Bell / Crash			LI28V01	92,00
ACCESSORIES				
Decentralization kit ◊	Decentralization for steel cables		KIT DEC B	28,00
	Decentralization for steel cables with canopy		KIT DEC F	49,00
	Canopy electrical decentralization		KIT DEC M	86,00

◊ Specifications see page 56



CAGE MIC

Diesel Creative Team 2009

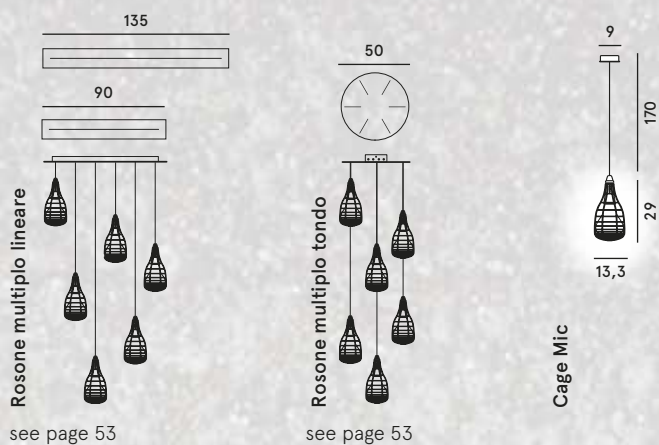

LIGHT BULBS (NOT INCLUDED)
halogen or LED retrofit 1x33W G9

WEIGHT
net kg 1,30

MATERIALS
Blown glass and
coated steel



> specifications p. 59

	COLOURS	ENERGY CLASS	CODE	VAT EXCLUDED
Cage Mic	Bianco	A ⁺ , A, C	LI0277 10 E	370,00
	Nero		LI0278 10 E	
Cage Mic h. 5 m	Bianco		LI0277 10 E5	389,00
	Nero		LI0278 10 E5	
VERSION WITHOUT CANOPY WITH MULTIPLE CANOPY HOLDER				
Cage Mic	Bianco	A ⁺ , A, C	LI0277SR 10 E	348,00
	Nero		LI0278SR 10 E	
Cage Mic h. 5 m	Bianco		LI0277SR 10E5	367,00
	Nero		LI0278SR 10E5	
SPARE PARTS				
Glass Cage Mic	Bianco		LI02V012 10	79,00
ACCESSORIES				
Decentralization kit ◊	Decentralization for power cable		KIT DEC C	33,00
	Canopy electrical decentralization		KIT DEC M	86,00

◊ Specifications see page 56



> pag. 30



> pag. 53

Cage mic bianco



Cage mic nero



Nero



Bianco



CAGE

Diesel Creative Team 2009

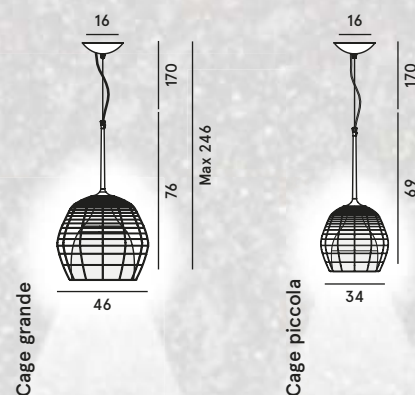

LIGHT BULBS (NOT INCLUDED)

Cage grande / Cage piccola
halogen 1x105W E27
LED retrofit or FLUO 1x20W E27

> specifications p. 59

WEIGHT

Cage grande
net kg 4,50

Cage piccola
net kg 3,00

MATERIALS

Laquered blown
glass, coated steel
and chromed metal



	COLOURS	ENERGY CLASS	CODE	VAT EXCLUDED
Cage grande	Bianco/Bianco	A ⁺ , A, C	LI0271 10 E	765,00
	Bianco/Nero		LI0271 20 E	
	Nero/Bianco		LI0272 10 E	
	Nero/Nero		LI0272 20 E	
	Marrone/Bronzo		LI0270 50 E	1.026,00
Cage grande h. 5 m	Bianco/Bianco	A ⁺ , A, C	LI0271 10 E5	783,00
	Bianco/Nero		LI0271 20 E5	
	Nero/Bianco		LI0272 10 E5	
	Nero/Nero		LI0272 20 E5	
	Marrone/Bronzo		LI0270 50 E5	1.044,00
Cage piccola	Bianco/Bianco	A ⁺ , A, C	LI0274 10 E	639,00
	Bianco/Nero		LI0274 20 E	
	Nero/Bianco		LI0275 10 E	
	Nero/Nero		LI0275 20 E	
	Marrone/Bronzo		LI0279 50 E	824,00
Cage piccola h. 5 m	Bianco/Bianco	A ⁺ , A, C	LI0274 10 E5	658,00
	Bianco/Nero		LI0274 20 E5	
	Nero/Bianco		LI0275 10 E5	
	Nero/Nero		LI0275 20 E5	
	Marrone/Bronzo		LI0279 50 E5	843,00
SPARE PARTS				
Glass Cage grande	Bianco		LI02VG 10 E	280,00
	Nero		LI02VG 20 E	
	Bronzo		LI02VG 50 E	453,00
Glass Cage piccola	Bianco		LI02VP 10 E	207,00
	Nero		LI02VP 20 E	
	Bronzo		LI02VP 50 E	291,00

CAGE

Diesel Creative Team 2009

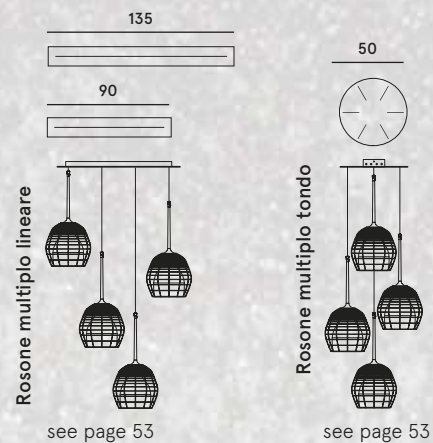

VERSION WITHOUT CANOPY WITH MULTIPLE CANOPY HOLDER	COLOURS	ENERGY CLASS	CODE	VAT EXCLUDED
Cage piccola	Bianco/Bianco	A ⁺ , A, C	LI0274SR 10 E	616,00
	Bianco/Nero		LI0274SR 20 E	
	Nero/Bianco		LI0275SR 10 E	
	Nero/Nero		LI0275SR 20 E	
	Marrone/Bronzo		LI0279SR 50 E	801,00
Cage piccola h. 5 m	Bianco/Bianco	A ⁺ , A, C	LI0274SR 10E5	635,00
	Bianco/Nero		LI0274SR 20E5	
	Nero/Bianco		LI0275SR 10E5	
	Nero/Nero		LI0275SR 20E5	
	Marrone/Bronzo		LI0279SR 50E5	820,00
ACCESSORIES				
Decentralization kit \diamond	Decentralization for steel cables		KIT DEC B	28,00
	Decentralization for steel cables with canopy		KIT DEC F	49,00
	Canopy electrical decentralization		KIT DEC M	86,00

\diamond Specifications see page 56

> pag. 29

> pag. 53

Cage grande



Cage piccola

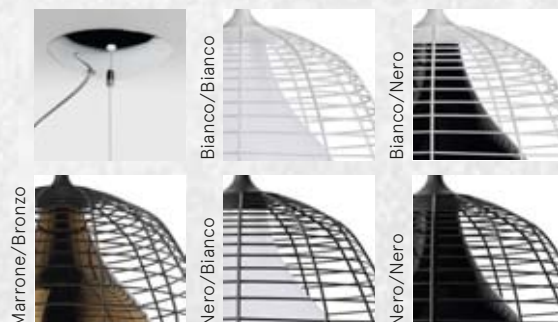

FORK

Diesel Creative Team 2010

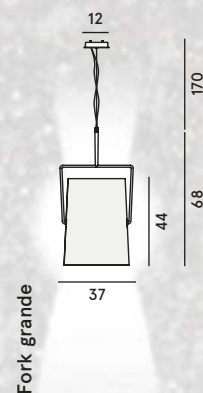

LIGHT BULBS (NOT INCLUDED)

Fork grande

halogen or LED retrofit
1x120W R7s (118mm)

Fork piccola

halogen or LED retrofit
1x48W R7s (78mm)

> specifications p. 59

adjustable lampshade

WEIGHT

Fork grande
net kg 2,50

Fork piccola
net kg 1,40

MATERIALS

Dyed linen,
polycarbonate and
coated steel

CERTIFICATIONS



	COLOURS	ENERGY CLASS	CODE	VAT EXCLUDED
Fork grande	Marrone/Grigio	A ⁺ , A, C	LI0471 25 E	677,00
	Marrone/Avorio		LI0471 50 E	
	Avorio/Grigio		LI0473 25 E	
	Avorio/Avorio		LI0473 50 E	
Fork grande h. 5 m	Marrone/Grigio	A ⁺ , A, C	LI0471 25 E5	701,00
	Marrone/Avorio		LI0471 50 E5	
	Avorio/Grigio		LI0473 25 E5	
	Avorio/Avorio		LI0473 50 E5	
SPARE PARTS	Lampshade Fork grande	Grigio	LI04DG 25 E	356,00
		Avorio	LI04DG 50 E	
Protection glass Fork grande			PIREX138/2S4I	20,00
ACCESSORIES	Decentralization kit ◊	Decentralization for steel cables	KIT DEC B	28,00
		Decentralization for steel cables with canopy	KIT DEC F	49,00
		Canopy electrical decentralization	KIT DEC M	86,00

◊ Specifications see page 56

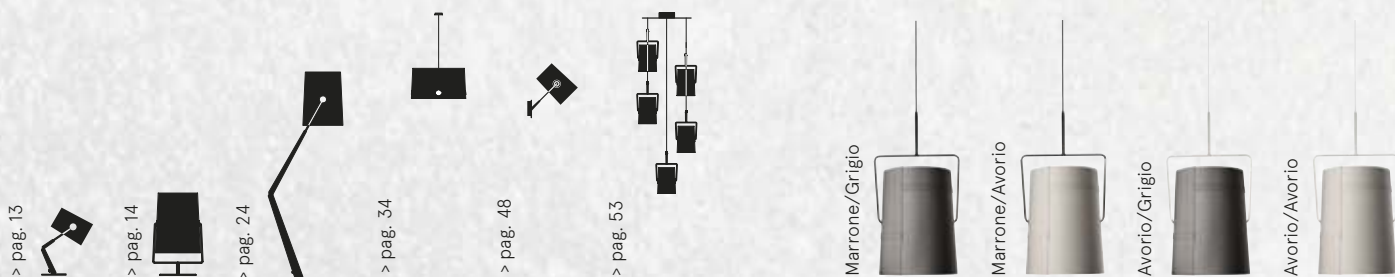

FORK

Diesel Creative Team 2010

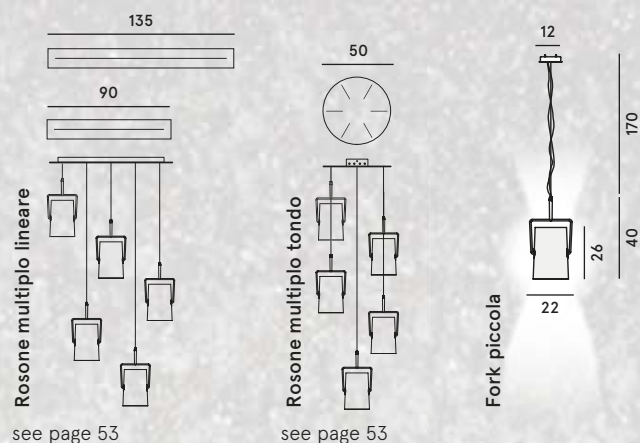

	COLOURS	ENERGY CLASS	CODE	VAT EXCLUDED
Fork piccola	Marrone/Grigio	A ⁺ , A, C	LI0472 25 E	513,00
	Marrone/Avorio		LI0472 50 E	
	Avorio/Grigio		LI0474 25 E	
	Avorio/Avorio		LI0474 50 E	
Fork piccola h. 5 m	Marrone/Grigio	A ⁺ , A, C	LI0472 25 E5	537,00
	Marrone/Avorio		LI0472 50 E5	
	Avorio/Grigio		LI0474 25 E5	
	Avorio/Avorio		LI0474 50 E5	
VERSION WITHOUT CANOPY WITH MULTIPLE CANOPY HOLDER				
Fork piccola	Marrone/Grigio	A ⁺ , A, C	LI0472SR 25E	492,00
	Marrone/Avorio		LI0472SR 50 E	
	Avorio/Grigio		LI0474SR 25 E	
	Avorio/Avorio		LI0474SR 50 E	
Fork piccola h. 5 m	Marrone/Grigio		LI0472SR 25E5	516,00
	Marrone/Avorio		LI0472SR 50E5	
	Avorio/Grigio		LI0474SR 25E5	
	Avorio/Avorio		LI0474SR 50E5	
SPARE PARTS				
Lampshade Fork piccola	Grigio		LI04DP 25 E	227,00
	Avorio		LI04DP 50 E	
Protection glass Fork piccola			PIREX98/2	8,00
ACCESSORIES				
Decentralization kit ◊	Decentralization for steel cables		KIT DEC B	28,00
	Decentralization for steel cables with canopy		KIT DEC F	49,00
	Canopy electrical decentralization		KIT DEC M	86,00

◊ Specifications see page 56



FORK XL

Diesel Creative Team 2014

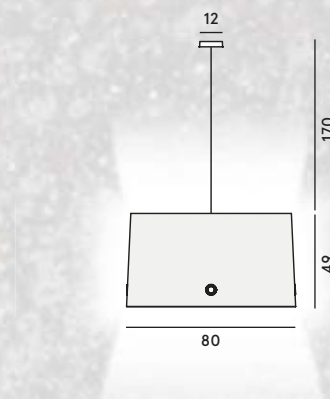

LIGHT BULBS (NOT INCLUDED)
halogen 3x116W E27
LED retrofit or FLUO 3x25W E27

> specifications p. 59

WEIGHT
net kg 4,00

MATERIALS
Dyed linen, satin
PMMA and varnished
steel



	COLOURS	ENERGY CLASS	CODE	VAT EXCLUDED
Fork XL	Grigio	A ⁺ , A, C	LI0475 25 E	1.156,00
	Avorio		LI0475 50 E	
Fork XL h. 5 m	Grigio	A ⁺ , A, C	LI0475 25 E5	1.180,00
	Avorio		LI0475 50 E5	
SPARE PARTS				
Lampshade Fork XL	Grigio		LI04DX 25 E	916,00
	Avorio		LI04DX 50 E	
ACCESSORIES				
Decentralization kit ◊	Decentralization for power cable		KIT DEC C	33,00
	Canopy electrical decentralization		KIT DEC M	86,00

◊ Specifications see page 56

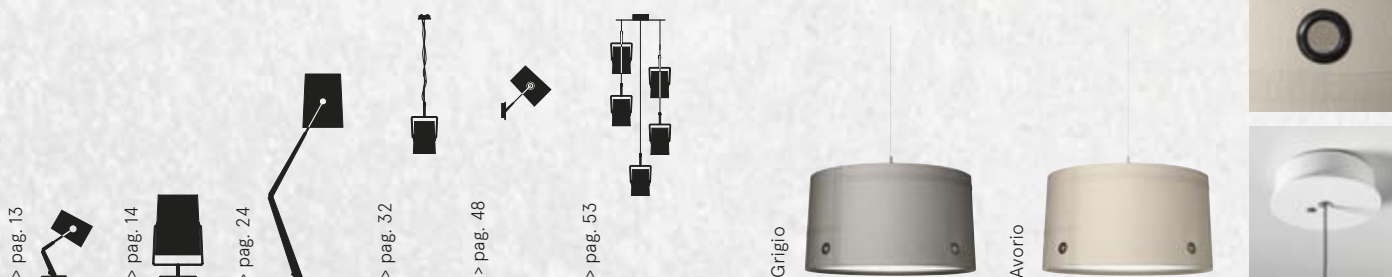

DRUMBOX

Diesel Creative Team 2011

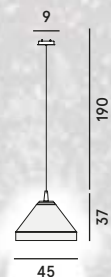

LIGHT BULBS (NOT INCLUDED)
LED retrofit or FLUO 1x20W E27

> specifications p. 59

WEIGHT
net kg 2,60

MATERIALS
Linen coupled with
techno polymer,
polyester,
thermoplastic
material and coated
steel

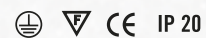

	COLOURS	ENERGY CLASS	CODE	VAT EXCLUDED
Drumbox	Bianco	A ⁺ , A	LI2071 10 E	481,00
Drumbox h. 5 m	Bianco	A ⁺ , A	LI2071 10 E5	492,00
ACCESSORIES				
Decentralization kit ◊	Decentralization for power cable		KIT DEC C	33,00
	Canopy electrical decentralization		KIT DEC M	86,00

◊ Specifications see page 56

> pag. 10



> pag. 23



Bianco



GASK

Diesel Creative Team 2014

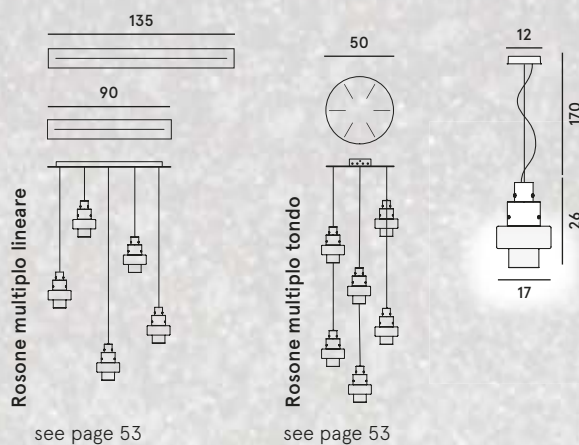

LIGHT BULBS (NOT INCLUDED)
halogen 1x46W E14
LED retrofit or FLUO 1x12W E14

> specifications p. 59

WEIGHT
net kg 2,40

MATERIALS
Blown glass and
varnished steel



	COLOURS	ENERGY CLASS	CODE	VAT EXCLUDED
Gask	Bianco	A ⁺ , A, C	LI3571 10 E	275,00
	Grigio		LI3571 25 E	
Gask h. 5 m	Bianco	A ⁺ , A, C	LI3571 10 E5	292,00
	Grigio		LI3571 25 E5	
VERSION WITHOUT CANOPY WITH MULTIPLE CANOPY HOLDER				
Gask	Bianco	A ⁺ , A, C	LI3571SR 10 E	264,00
	Grigio		LI3571SR 25 E	
Gask h. 5 m	Bianco	A ⁺ , A, C	LI3571SR 10E5	280,00
	Grigio		LI3571SR 25E5	
SPARE PARTS				
Glass Gask	Bianco		LI35VH 10 E	66,00
	Grigio		LI35VH 25 E	
ACCESSORIES				
Decentralization kit ◊	Decentralization for steel cables		KIT DEC B	28,00
	Decentralization for steel cables with canopy		KIT DEC F	49,00
	Canopy electrical decentralization		KIT DEC M	86,00

◊ Specifications see page 56

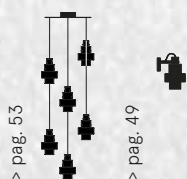

> pag. 53

> pag. 49



Bianco

Grigio



GLAS

Diesel Creative Team 2009

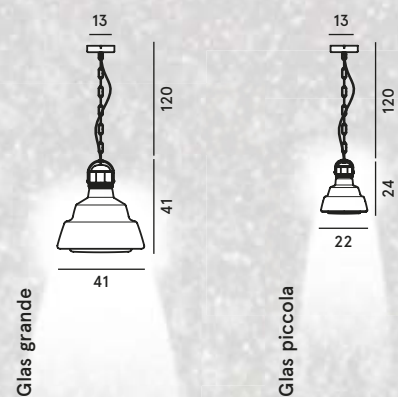
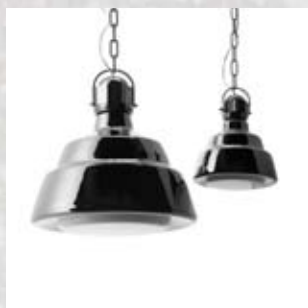

LIGHT BULBS (NOT INCLUDED)

Glas grande

halogen 1x105W E27
LED retrofit or FLUO 1x23W E27

WEIGHT

Glas grande
net kg 4,30

MATERIALS

Metallized or sandblasted blown glass, thermoplastic material and nickel-plated steel

Glas grande



Glas piccola

LED retrofit or FLUO 1x21W E27

Glas piccola

net kg 2,10

Glas piccola



> specifications p. 59

	COLOURS	ENERGY CLASS	CODE	VAT EXCLUDED
Glas grande	Cromo	A ⁺ , A, C	LI0171 78 E	795,00
	Bianco		LI0171 10 E	627,00
Glas grande h. 5 m	Cromo	A ⁺ , A, C	LI0171 78 E5	837,00
	Bianco		LI0171 10 E5	669,00
Glas piccola	Cromo	A ⁺ , A,	LI0172 78 E	501,00
	Bianco		LI0172 10 E	390,00
Glas piccola h. 5 m	Cromo	A ⁺ , A,	LI0172 78 E5	539,00
	Bianco		LI0172 10 E5	428,00
SPARE PARTS				
Glass Glas grande	Cromo		LI01VG 78 E	507,00
	Bianco		LI01VG 10 E	339,00
Glass Glas piccola	Cromo		LI01VP 78 E	246,00
	Bianco		LI01VP 10 E	135,00
ACCESSORIES				
Decentralization kit ◊	Canopy electrical decentralization		KIT DEC M	86,00

◊ Specifications see page 56

> pag. 15



Grande cromo



Piccola cromo



Grande bianco



Piccola bianco

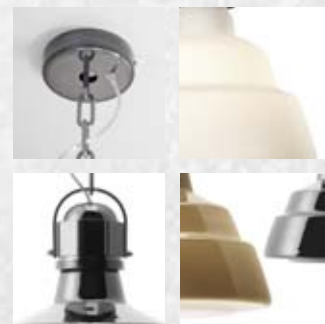

GLASS DROP

Diesel Creative Team 2013

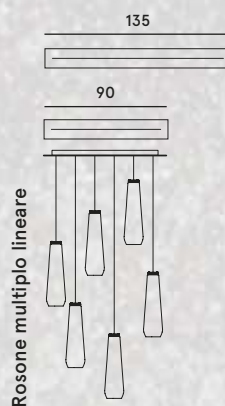

see page 53

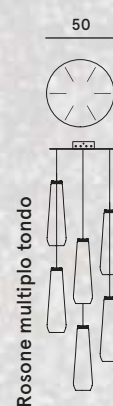

see page 53

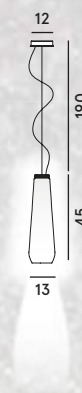

LIGHT BULBS (NOT INCLUDED)
halogen 1x57W E27
LED retrofit or FLUO 1x15W E27

> specifications p. 59

WEIGHT
net kg 1,80

MATERIALS
Metallized
blown glass and
thermoplastic
material



	COLOURS	ENERGY CLASS	CODE	VAT EXCLUDED
Glass Drop	Cromo	A ⁺ , A, C	LI3007 78 E	437,00
	Bianco		LI3007 10 E	328,00
Glass Drop h. 5 m	Cromo	A ⁺ , A, C	LI3007 78 E5	459,00
	Bianco		LI3007 10 E5	350,00
VERSION WITHOUT CANOPY WITH MULTIPLE CANOPY HOLDER				
Glass Drop	Cromo	A ⁺ , A, C	LI3007SR 78 E	426,00
	Bianco		LI3007SR 10 E	316,00
Glass Drop h. 5 m	Cromo	A ⁺ , A, C	LI3007SR 78E5	448,00
	Bianco		LI3007SR 10E5	338,00
SPARE PARTS				
Glass Glass Drop	Cromo		LI30V 78 E	290,00
	Bianco		LI30V 10 E	181,00
ACCESSORIES				
Decentralization kit ◊	Decentralization for steel cables		KIT DEC B	28,00
	Decentralization for steel cables with canopy		KIT DEC F	49,00
	Canopy electrical decentralization		KIT DEC M	86,00

◊ Specifications see page 56

> pag. 16



> pag. 53



Cromo



Bianco



on

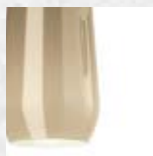

off



Cromo



Bianco



METAL GLASS

Diesel Creative Team 2012

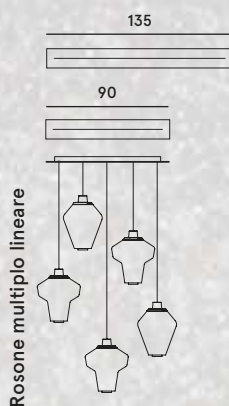

see page 53

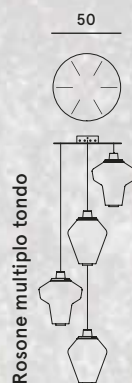

see page 53

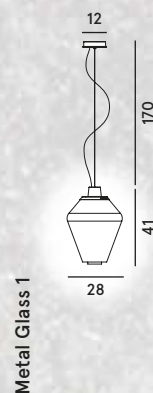

Metal Glass 1

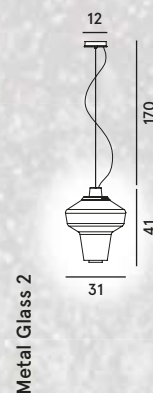

Metal Glass 2

LIGHT BULBS (NOT INCLUDED)
halogen 1x105W E27
LED retrofit or FLUO 1x25W E27

> specifications p. 59

WEIGHT
Metal Glass 1
net kg 3,50

Metal Glass 2
net kg 3,80

MATERIALS
Blown glass, Pyrex
and lacquered steel



	COLOURS	ENERGY CLASS	CODE	VAT EXCLUDED
Metal Glass 1	Grigio	A ⁺ , A, B, C	LI2271 25 E	568,00
	Ambra		LI2271 52 E	
Metal Glass 2	Grigio	A ⁺ , A, B, C	LI2272 25 E	568,00
	Verde		LI2272 40 E	
Metal Glass 1 H 5 m	Grigio	A ⁺ , A, B, C	LI2271 25 E5	588,00
	Ambra		LI2271 52 E5	
Metal Glass 2 H 5 m	Grigio	A ⁺ , A, B, C	LI2272 25 E5	588,00
	Verde		LI2272 40 E5	
VERSION WITHOUT CANOPY WITH MULTIPLE CANOPY HOLDER				
Metal Glass 1	Grigio	A ⁺ , A, B, C	LI2271SR 25 E	556,00
	Ambra		LI2271SR 52 E	
Metal Glass 2	Grigio	A ⁺ , A, B, C	LI2272SR 25 E	556,00
	Verde		LI2272SR 40 E	
Metal Glass 1 h. 5 m	Grigio	A ⁺ , A, B, C	LI2271SR 25E5	576,00
	Ambra		LI2271SR 52E5	
Metal Glass 2 h. 5 m	Grigio	A ⁺ , A, B, C	LI2272SR 25E5	576,00
	Verde		LI2272SR 40E5	
SPARE PARTS				
Glass Metal Glass 1	Grigio		LI22V3 25 E	236,00
	Ambra		LI22V3 52 E	
Glass Metal Glass 2	Grigio		LI22V4 25 E	236,00
	Verde		LI22V4 40 E	
ACCESSORIES				
Decentralization kit ◊	Decentralization for steel cables		KIT DEC B	28,00
	Decentralization for steel cables with canopy		KIT DEC F	49,00
	Canopy electrical decentralization		KIT DEC M	86,00

Specifications see page 56



MYSTERIO

Diesel Creative Team 2011

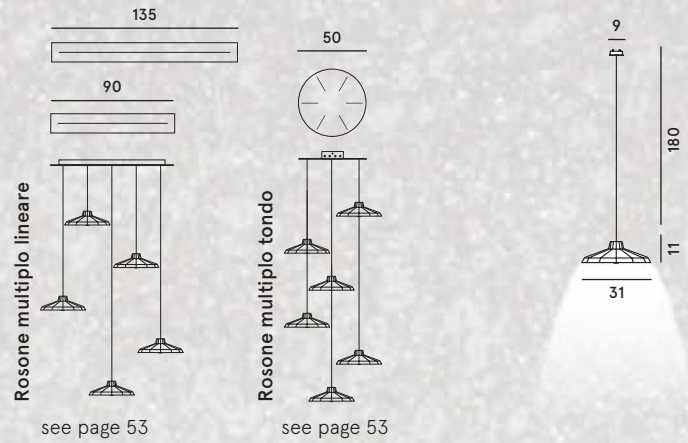

LIGHT BULBS (NOT INCLUDED)
halogen or LED retrofit 1x33W G9

> specifications p. 59

WEIGHT
net kg 0,80

MATERIALS
Metallized batch-dyed polycarbonate and blown glass



	COLOURS	ENERGY CLASS	CODE	VAT EXCLUDED
Mysterio	Bianco-rame	A ⁺ , C	LI1971 10 E1	202,00
	Nero-argento		LI1971 20 E1	
Mysterio h. 5 m	Bianco-rame	A ⁺ , C	LI1971 10 E51	219,00
	Nero-argento		LI1971 20 E51	
VERSION WITHOUT CANOPY WITH MULTIPLE CANOPY HOLDER				
Mysterio	Bianco-rame	A ⁺ , C	LI1971SR 10 E1	190,00
	Nero-argento		LI1971SR 20 E1	
Mysterio h. 5 m	Bianco-rame	A ⁺ , C	LI1971SR 10E51	207,00
	Nero-argento		LI1971SR 20E51	
ACCESSORIES				
Decentralization kit ◊	Decentralization for power cable		KIT DEC C	33,00
	Canopy electrical decentralization		KIT DEC M	86,00

◊ Specifications see page 56



PYLON

Diesel Creative Team 2014

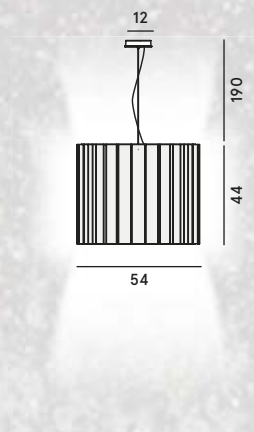

LIGHT BULBS (NOT INCLUDED)

halogen 1x116W E27
LED retrofit or FLUO 1x25W E27

WEIGHT
net kg 1,80

MATERIALS
Dyed linen, PVC and
varnished steel



> specifications p. 59

	COLOURS	ENERGY CLASS	CODE	VAT EXCLUDED
Pylon	Avorio	A ⁺ , A, B, C	LI3771 50 E	683,00
Pylon h. 5 m	Avorio	A ⁺ , A, B, C	LI3771 50 E5	704,00
SPARE PARTS				
Lampshade Pylon	Avorio		LI37D 50 E	563,00
ACCESSORIES				
Decentralization kit ◊		Decentralization for steel cables	KIT DEC B	28,00
		Decentralization for steel cables with canopy	KIT DEC F	49,00
		Canopy electrical decentralization	KIT DEC M	86,00

◊ Specifications see page 56

> pag. 26



Avorio



ROCK

Diesel Creative Team 2009

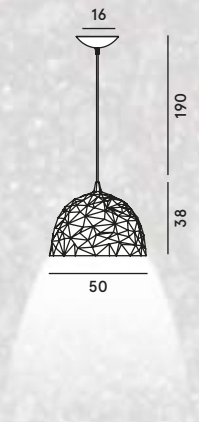

LIGHT BULBS (NOT INCLUDED)

LED retrofit or FLUO 1x23W E27
Recommended white globe bulb Ø 12 cm

WEIGHT

net kg 2,30

MATERIALS

Moulded coated ABS
+ polycarbonate



> specifications p. 59

	COLOURS	ENERGY CLASS	CODE	VAT EXCLUDED
Rock	Bianco	A ⁺ , A	LI0507 10 E1	454,00
	Nero		LI0507 52 E1	
	Oro		LI0507 50 E1	
Rock h. 5 m	Bianco	A ⁺ , A	LI0507 10 E51	465,00
	Nero		LI0507 52 E51	
	Oro		LI0507 50 E51	
ACCESSORIES				
Decentralization kit ◊	Decentralization for power cable		KIT DEC C	33,00
	Canopy electrical decentralization		KIT DEC M	86,00

◊ Specifications see page 56



> pag. 27

SMASH

Diesel Creative Team 2016

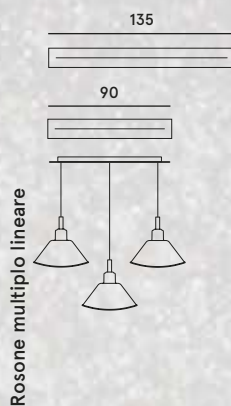

see page 53

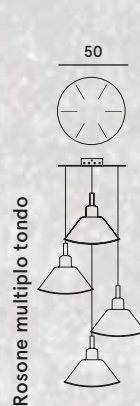

see page 53

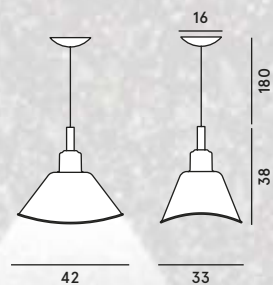

LIGHT BULBS (NOT INCLUDED)
LED retrofit or FLUO 1x10W E27
halogen 1x57W E27

> specifications p. 59

WEIGHT
net kg 1,80

MATERIALS
Pressed glass,
aluminium, steel and
laquered metal



	COLOURS	ENERGY CLASS	CODE	VAT EXCLUDED
Smash	Grigio	A ⁺ , A, C	LI4171 25 E	454,00
	Rust		LI4171 52 E	
Smash h. 5 m	Grigio	A ⁺ , A, C	LI4171 25 E5	465,00
	Rust		LI4171 52 E5	

VERSION WITHOUT CANOPY WITH MULTIPLE CANOPY HOLDER

Smash	Grigio	A ⁺ , A, C	LI4171SR 25 E	443,00
	Rust		LI4171SR 52 E	
Smash h. 5 m	Grigio	A ⁺ , A, C	LI4171SR 25E5	454,00
	Rust		LI4171SR 52E5	

ACCESSORIES

Decentralization kit ◊	Decentralization for power cable	KIT DEC C	33,00
	Canopy electrical decentralization	KIT DEC M	86,00

◊ Specifications see page 56



> pag. 51



> pag. 53

Grigio



Rust



TOOL

Diesel Creative Team 2010

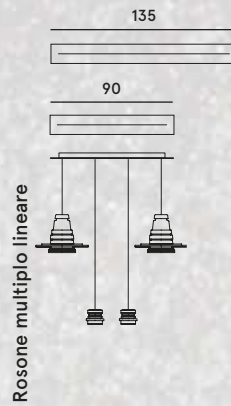

see page 53

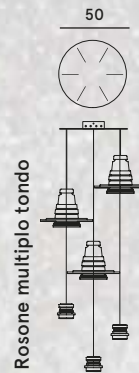

see page 53

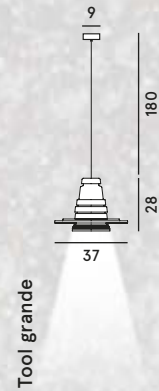

Tool grande

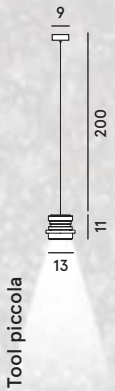

Tool piccola

LIGHT BULBS (NOT INCLUDED)

Tool grande
halogen or LED retrofit 1x60W G9

Tool piccola
halogen 1x35W GU10 PAR
LED retrofit 1x8W GU10 PAR

> specifications p. 59

WEIGHT

Tool grande
net kg 2,50

Tool piccola
net kg 0,60

MATERIALS

Colored
polyurethane and
aluminium

Tool grande

Colored
polyurethane and
aluminium
IP 20

Tool piccola



	COLOURS	ENERGY CLASS	CODE	VAT EXCLUDED
Tool grande	Nero	C	LI0971 20 E	277,00
Tool grande h. 5 m	Nero	C	LI0971 20 E5	294,00
Tool piccola	Nero	A ⁺ , A, B, C	LI0972 20 E	164,00
Tool piccola h. 5 m	Nero	A ⁺ , A, B, C	LI0972 20 E5	180,00

VERSION WITHOUT CANOPY WITH MULTIPLE CANOPY HOLDER

Tool grande	Nero	C	LI0971SR 20 E	265,00
Tool grande h. 5 m	Nero	C	LI0971SR 20E5	282,00
Tool piccola	Nero	A ⁺ , A, B, C	LI0972SR 20 E	152,00
Tool piccola h. 5 m	Nero	A ⁺ , A, B, C	LI0972SR 20E5	168,00

ACCESSORIES

Decentralization kit ◊	Decentralization for power cable	KIT DEC C	33,00
	Canopy electrical decentralization	KIT DEC M	86,00

◊ Specifications see page 56

> pag. 53



Tool grande

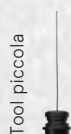

Tool piccola



WHITE NOISE



Diesel Creative Team 2016

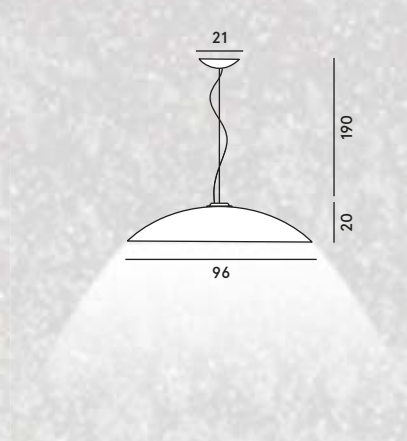

LED INCLUDED

46W COB 3000°K

4312 lm CRI>90 93,7 lm/W

WEIGHT

net kg 12,30

MATERIALS

Varnished
aluminium
and ABS



Dimmable version possible configurations:
On-Off /Push/DALI

	COLOURS	ENERGY CLASS	CODE	VAT EXCLUDED
White Noise	Nero	A	LI4007 20 E	1.549,00
White Noise h. 5 m	Nero	A	LI4007 20 E5	1.580,00
White Noise dimmable	Nero	A	LI4007D 20 E	1.611,00
White Noise dimmable h. 5 m	Nero	A	LI4007D 20 E5	1.643,00
ACCESSORIES				
Decentralization kit ◊	Decentralization for steel cables		KIT DEC B	28,00

◊ Specifications see page 56

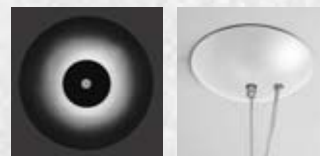

MYSTERIO

Diesel Creative Team 2011

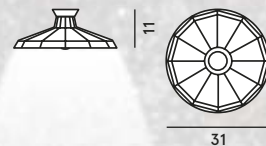

LIGHT BULBS (NOT INCLUDED)
halogen or LED retrofit 1x33W G9

> specifications p. 59

WEIGHT
net kg 0,80

MATERIALS
Metallized batch-dyed polycarbonate and blown glass

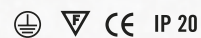

	COLOURS	ENERGY CLASS	CODE	VAT EXCLUDED
Mysterio	Bianco-rame	A ⁺ , C	LI1951 10 E1	200,00
	Nero-argento		LI1951 20 E1	

> pag. 40

> pag. 50



Bianco-rame



Nero-argento



DUII MINI

Diesel Creative Team 2012

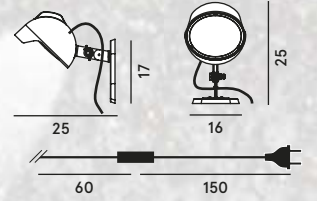

LIGHT BULBS (NOT INCLUDED)
LED retrofit 1x10W R7s (78mm)

> specifications p. 59

WEIGHT
net kg 1,40

MATERIALS
Pressed glass,
aluminium, steel and
laquered metal



adjustable lampshade,
with personalized packaging

	COLOURS	ENERGY CLASS	CODE	VAT EXCLUDED
Duii mini	Grigio	A ⁺ , A	LI1812 25 E1	295,00
	Giallo		LI1812 50 E1	

> pag. 11



> pag. 12



Giallo



Grigio



FORK

Diesel Creative Team 2013

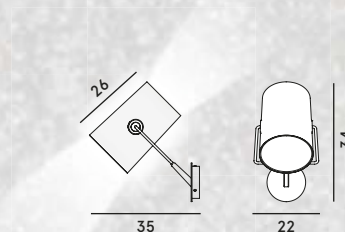

LIGHT BULBS (NOT INCLUDED)
halogen or LED retrofit 1x48W R7s (78mm)

WEIGHT
net kg 1,20

MATERIALS
Dyed linen,
polycarbonate and
coated steel



> specifications p. 59

adjustable lampshade

	COLOURS	ENERGY CLASS	CODE	VAT EXCLUDED
Fork	Marrone/Grigio	A ⁺ , A, C	LI0451 25 E	540,00
	Marrone/Avorio		LI0451 50 E	
	Avorio/Grigio		LI0452 25 E	
	Avorio/Avorio		LI0452 50 E	
SPARE PARTS				
Lampshade Fork	Grigio		LI04DP 25 E	227,00
	Avorio		LI04DP 50 E	
Protection glass			PIREX98/2	8,00

> pag. 13



> pag. 14



> pag. 24



> pag. 32



> pag. 34



> pag. 53



Marrone/Grigio



Marrone/Avorio



Avorio/Grigio



Avorio/Avorio



GASK

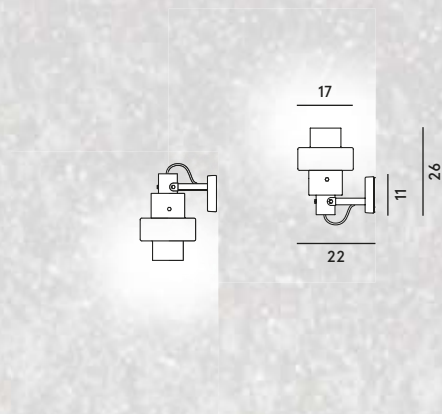

LIGHT BULBS (NOT INCLUDED)
LED retrofit or FLUO 1x12W E14
halogen 1x46W E14

WEIGHT
net kg 2,5



	COLOURS	ENERGY CLASS	CODE	VAT EXCLUDED
Gask	Bianco	A ⁺ , A, B, C	L13551 10 E	379,00
	Grigio		L13551 25 E	

> pag. 36



bianco



grigio



MYSTERIO

Diesel Creative Team 2011

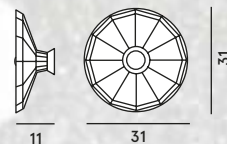
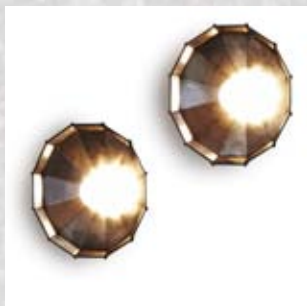

LIGHT BULBS (NOT INCLUDED)
halogen or LED retrofit 1x33W G9

WEIGHT
net kg 0,80

MATERIALS
Metallized batch-dyed polycarbonate and blown glass



> specifications p. 59

	COLOURS	ENERGY CLASS	CODE	VAT EXCLUDED
Mysterio	Bianco-rame	A+, C	LI1951 10 E1	200,00
	Nero-argento		LI1951 20 E1	

> pag. 40



> pag. 46



Bianco-rame



Nero-argento



SMASH

Diesel Creative Team 2016

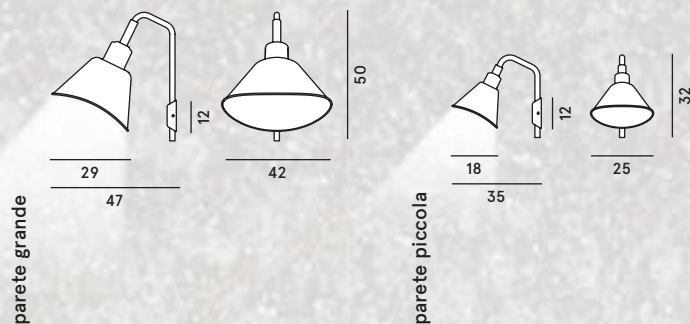

LIGHT BULBS (NOT INCLUDED)

LED retrofit or FLUO 1x10W E27
halogen 1x57W E27

WEIGHT

Smash grande
net kg 2,00

Smash piccola
net kg 1,80

MATERIALS

Varnished
aluminium and
metal



* on demand version with external
cable, switch and plug

PARETE	COLORI	CLASSE ENERGETICA	CODE	VAT EXCLUDED
Smash grande	Grigio	A ⁺ , A, B, C	LI4151 25 E	631,00
	Rust		LI4151 52 E	
Smash piccola	Grigio	A ⁺ , A, B, C	LI4152 25 E	496,00
	Rust		LI4152 52 E	
Smash grande with plug *	Grigio	A ⁺ , A, B, C	LI4151S 25 E	657,00
	Rust		LI4151S 52 E	
Smash piccola with plug *	Grigio	A ⁺ , A, B, C	LI4152S 25 E	522,00
	Rust		LI4152S 52 E	

> pag. 43



grigio



rust



grigio con spina



rust con spina



ACCESSORIES: MULTIPLE CANOPIES

GASK



ACCESSORIES: MULTIPLE CANOPIES

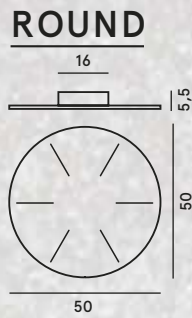

Round multiple canopy
Lacquered metal

WEIGHT
net kg 9,00



LINEAR

Linear multiple canopy 90
Lacquered metal

WEIGHT
net kg 7,00

Linear multiple canopy 135
Lacquered metal

net kg 10,00

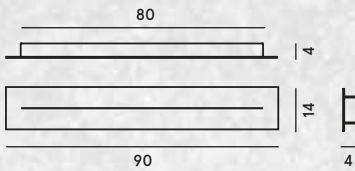

Linear multiple canopy 90

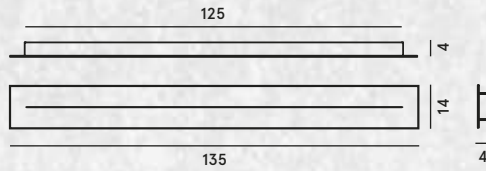

Linear multiple canopy 135

ADVICE ON INSTALLATION

MODEL	ROUND MULTIPLE CANOPY	LINEAR MULTIPLE CANOPY 90	LINEAR MULTIPLE CANOPY 135
Cage piccola	max 6	max 6	max 9
Cage Mic	max 9	max 5	max 7
Fork piccola	max 6	max 6	max 9
Glass Drop	max 9	max 6	max 9
Gask	max 9	max 5	max 9
Metal Glass 1	max 6	max 6	max 9
Metal Glass 2	max 6	max 5	max 8
Mysterio	max 6	max 5	max 8
Smash	max 6	max 5	max 7
Tool grande	max 6	max 5	max 7
Tool piccola	max 9	max 6	max 9

Max. refers to installation in staggered composition

ACCESSORIES	COLOURS	CODE	VAT EXCLUDED
Round multiple canopy	Bianco	ROSONE01D 10	416,00
Linear multiple canopy 90	Bianco	ROSONE02D 10	349,00
Linear multiple canopy 135	Bianco	ROSONE03D 10	464,00

MULTIPLE COMPOSITIONS

A technical solution combining practicality and harmony of form. Foscarini's multiple rosettes give you the chance to create large effect compositions of up to nine hanging lamps. In the round rosette lamps can be positioned at different heights to make a light waterfall. Linear rosettes are available in two sizes - 90 or 135 cm (35 7/16" or 53 5/32") - and can be used alone or in sequence to create rows of various lengths.

SMASH



CAGE



CAGE MIC



FORK PICCOLA



TOOL



GLASS DROP



METAL GLASS



GLASS DROP



MYSTERIO



GASK

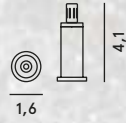

ACCESSORIES:DECENTRALIZATION KITKIT B**Kit B**

Decentralization for steel cables
includes 3 steel cable supports

For the models:

**Bell - Cage grande-piccola - Crash - Fork - Gask - Glass
Drop - Metal Glass - Pylon**

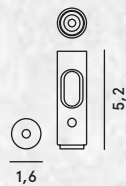
KIT C**Kit C**

Decentralization for power cable



For the models:

**Cage Mic - Drumbox - Fork XL - Mysterio - Rock - Smash -
Tool**

ACCESSORIES

Decentralization for steel cables
Decentralization for power cable

CODE

KIT DEC B

KIT DEC C

VAT EXCLUDED

28,00

33,00

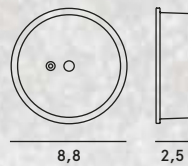
ACCESSORIES:DECENTRALIZATION KITKIT F**Kit F**

Decentralization for steel cables
includes 3 steel cable supports and a white canopy



For the models:

Bell - Cage grande-piccola - Crash - Fork - Gask - Glass Drop - Metal Glass - Pylon

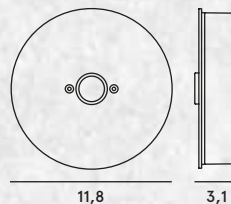
KIT M**Kit M**

Canopy electrical decentralization up to 4 lamps.

The kit M contains only the canopy, for compositions in the pictures order the necessary quantity of Kit B or Kit C.



For the models:

Bell - Cage grande-piccola-Mic - Crash - Drumbox - Fork-XL - Gask - Glas - Glass Drop - Metal Glass- Mysterio - Rock - Smash - Tool - Pylon

ACCESSORIES

Decentralization for steel cables with canopy
Canopy electrical decentralization

CODE

KIT DEC F
KIT DEC M

VAT EXCLUDED

49,00
86,00

PACKING

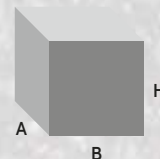



Model	Version	N° boxes	Description	Net weight kg	Gross weight kg	Size cm	A x B x H	
Bell	Sospensione	1	diffuser	1,1	2,6	50	50 x 30	
		1	frame	1,1	1,6	31	22 x 23	
Cage	grande	Sospensione	1	glass	3,2	3,7	41	41 x 46
			1	cage	0,7	2,9	47	47 x 44
		1	frame	0,6	2,5	76	18 x 18	
	piccola	Sospensione	1	cage	0,4	2,3	36	36 x 34
			1	frame	0,6	2,3	76	18 x 18
			1	glass	2,0	2,2	31	31 x 36
	Mic	Sospensione	1	1,3	2,1	23	32 x 37	
Crash	Sospensione	1	diffuser	1,1	3,5	75	75 x 12	
		1	frame	1,1	1,6	31	22 x 23	
Drumbox	Sospensione	1		2,6	3,7	53	53 x 43	
	Tavolo	1		2,6	3,7	53	53 x 43	
	Terra	1	diffuser	2,6	3,7	53	53 x 43	
		1	stem	1,2	2,2	142	5 x 5	
		1	base	6,0	8,7	52	47 x 4	
Duii	Tavolo	1		4,1	6,3	43	25 x 32	
Duii Mini	Tavolo/Parete	1		1,4	2,5	32	23 x 27	
Fork	grande	Sospensione	1	diffuser	0,5	1,8	35	35 x 47
			1	frame	2,0	2,5	56	45 x 9
	piccola	Sospensione	1	diffuser	0,3	0,7	20	20 x 29
			1	frame	1,1	1,3	37	25 x 8
			1	diffuser	0,3	0,7	20	20 x 29
		Parete	1	diffuser	0,3	0,7	20	20 x 29
			1	frame	0,9	2,2	38	25 x 29
			1	diffuser	0,3	0,7	20	20 x 29
	Tavolo	1	frame	2,1	3,7	59	25 x 30	
		1	diffuser	0,5	1,8	35	35 x 47	
	Terra	1	frame	11,0	18,5	176	47 x 18	
		1	diffuser	0,5	1,8	35	35 x 47	
	maxi	Tavolo	1	diffuser	0,5	1,8	35	35 x 47
			1	frame	3,3	4,0	45	45 x 8
	mini	Tavolo	1	diffuser	0,3	0,7	20	20 x 29
			1	frame	2,0	3,7	32	29 x 8
XL	Sospensione	1	diffuser	3,0	4,0	84	84 x 25	
		1	frame	1,0	1,8	28	27 x 23	
Gask	Parete	1	glass	1,0	1,5	25	25 x 27	
		1	frame	1,4	1,8	24	20 x 26	
	Sospensione	1	glass	1,0	1,5	25	25 x 27	
		1	frame	1,4	1,8	18	18 x 27	
Glas	grande	Sospensione	1	glass	3,7	5,8	48	48 x 46
			1	frame	0,6	2,3	31	26 x 18
	piccola	Sospensione	1	glass	1,5	2,2	28	28 x 26
			1	frame	0,6	1,5	26	26 x 18
		Tavolo	1	glass	1,5	2,2	28	28 x 26
			1	frame	5,0	5,8	27	27 x 49
Glass Drop	Sospensione	1		1,8	2,8	58	20 x 19	
	Tavolo	1		7,9	10,7	49	49 x 55	
Hexx	Tavolo	1		6,5	10,6	50	40 x 60	
Metafisica	Tavolo	1	glass	3,7	5,8	48	48 x 40	
		1	frame	1,3	2,0	29	29 x 43	
Metal Glass	1	Sospensione	1	glass	2,6	4,2	41	41 x 30
			1	frame	0,9	2,0	43	33 x 20
		Tavolo	1	glass	2,6	4,2	41	41 x 30
			1	frame	1,2	2,2	43	33 x 20
	2	Sospensione	1	glass	3,6	4,2	41	41 x 30
			1	frame	0,9	2,0	43	33 x 20
	Tavolo	1	glass	3,6	4,2	41	41 x 30	
		1	frame	1,2	2,2	43	33 x 20	
Mysterio	Parete/Soffitto	1		0,8	2,1	39	39 x 19	
	Sospensione	1		0,8	2,1	39	39 x 19	
Pett	Tavolo	1		0,7	2,9	54	26 x 38	
Pipe	grande	Terra	1	upper diffuser	2,1	5,3	78	62 x 62
			1	lower diffuser	1,9	6,4	118	38 x 38
			1	frame	4,5	6,4	48	48 x 16

Model	Version	N° boxes	Description	Net weight kg	Gross weight kg	Size cm	A x B x H
Pipe	media	1	upper diffuser	2,6	4,8	74	74 49
			lower diffuser	1,9	6,4	118	38 38
			frame	4,5	6,7	48	48 16
	Tavolo	1	diffuser set	2,2	4,5	82	56 40
			frame	1,1	1,9	31	31 11
Pylon	Sospensione	1	diffuser	1,5	4,5	60	60 56
			frame	0,3	0,6	19	19 14
	Terra	1	frame	7,3	10,0	108	48 48
			diffuser	1,5	4,5	60	60 56
Rock	Sospensione	1	diffuser	2,3	5,3	53	53 43
	Terra	1	stem	1,2	1,5	132	5 5
			diffuser	2,3	5,0	53	53 43
			base	6,0	6,4	52	47 4
Smash	Sospensione	1	diffuser	1,8	2,5	49	40 47
	grande	1	Parete	2,0	2,9	59	49 52
	piccola		Parete	1,8	2,7	47	31 36
Soft Power	grande	1	Tavolo	1,0	3,2	46	46 46
	piccola	1	Tavolo	0,6	1,7	33	33 35
Tool	grande	1	Sospensione	2,5	3,6	41	41 30
	piccola	1	Sospensione	0,6	0,9	14	14 16
Whitenoise	Sospensione	1	diffuser	11,4	12,4	109	27 107
			canopy	1,0	1,9	24	24 9
Rosone multiplo	tondo	1	diffuser	9,0	10,7	61	61 9
	lineare 90 cm	1	diffuser	6,8	7,7	100	27 9
	lineare 135 cm	1	diffuser	10,0	11,5	145	27 9

LIGHT SOURCES

According to the European norms, starting from 1st of September, the lighting fixtures equipped with bulbs that can be replaced by the final user have to be compatible with A+ bulbs (LED retrofit). The Foscarini lamps comply already with this requirement. Since a couple of years our price list states the possibility to use led retrofit bulbs besides the recommended halogen bulbs. If the fixture is supplied with a Pyrex glass, it has to be removed. If a dimmer is foreseen (whether included or not), it has to be used at full power in order to avoid damages to the retrofit bulb. Even when using dimmable led retrofit bulbs, the correct dimming function is not granted. The actual state of the art of LED retrofit bulbs does not allow to obtain the same light flux as the halogen bulbs recommended by Foscarini. In order to give a more complete information, we remind you that the exit of halogen bulbs from the EU market has presently been postponed to September 1, 2018. This table contains the necessary information to purchase the correct light source (Foscarini models with integrated LED excluded). The light tones may vary from one bulb to another. Foscarini recommends the use of warm light bulbs for its whole collection. The light bulbs available on the market may feature technical specifications with various graphics and definitions, but a warm light tone is generally described as: Warm White - 2700- 3000K* and CRI > 80. * expressed in mm

Model	Version	Type	Fitting base	Lenght*	Width*	Notes
Bell-Crash	sospensione	LED retrofit or FLUO/HALO	E27	max 140	max Ø60	
Cage Grande	sospensione	LED retrofit or FLUO/HALO	E27	max 120		
Cage mic	sospensione	LED retrofit/HALO	G9			
Cage Piccola	sospensione	LED retrofit or FLUO/HALO	E27	max 120		
Drumbox	tavolo/terra/sospensione	LED retrofit or FLUO	E27	max 120	max Ø60	
Duii - Dui Mini	tavolo/parete (mini)	LED retrofit	R7s	78	max Ø23	
Fork Maxi/Terra/Grande	tavolo/terra/sospensione	LED retrofit/HALO	R7s	118	max Ø23	
Fork Tavolo/Mini/Piccola/Parete	tavolo/sospensione/parete	LED retrofit/HALO	R7s	78	max Ø23	
Fork XL	sospensione	LED retrofit or FLUO/HALO	E27			
Gask	sospensione	LED retrofit or FLUO/HALO	E14	max 80	max Ø60	
Glas Grande	sospensione	LED retrofit or FLUO/HALO	E27	180	max Ø60	
Glas Tavolo/Piccola	tavolo/sospensione	LED retrofit or FLUO	E27	150	max Ø48	
Glass Drop Sospensione	sospensione	LED retrofit or FLUO/HALO	E27		max Ø85	
Glass Drop Tavolo	tavolo	LED retrofit dimmer. /HALO	E27	150	max Ø140	
Hexx	tavolo	LED retrofit or FLUO/HALO	E27 PAR		max Ø150	
Metafisica	tavolo	LED retrofit dimmer. /HALO	E27		max Ø100	
Metal Glass	tavolo/sospensione	LED retrofit or FLUO/HALO	E27		max Ø60	
Mysterio	sospensione/soffitto/parete	HALO or LED retrofit	G9			
Pett	tavolo	LED retrofit or FLUO	E14		max Ø70	
Pipe tavolo	tavolo	LED retrofit or FLUO	E27	max 120		
Pipe terra	terra	LED retrofit dimmer. /HALO	E27			
Pylon sospensione	sospensione	LED retrofit or FLUO/HALO	E27			
Pylon Terra	terra	LED retrofit dimmer. /HALO	E27			
Rock	terra/sospensione	LED retrofit or FLUO	E27		Ø120	globe bulb recommended
Soft Power grande	tavolo	LED retrofit or FLUO/HALO	E27		max 230	
Soft Power piccola	tavolo	LED retrofit or FLUO/HALO	E14		max 150	
Tool Grande	sospensione	LED retrofit dimmer. /HALO	G9	max Ø60	max Ø18	
Tool Piccola	sospensione	LED retrofit/HALO	GU10-PAR	max 80	max Ø55	

Foscarini SpA
via delle Industrie 27
30020 Marcon / Venezia /Italy
T +39 041 595 3811
F +39 041 595 3820
foscarini@foscarini.com

Foscarini Inc
17 Greene Street, New York
NY /10013 / USA
T +1 212 247 2218
F +1 646 545 2564
foscarini.inc@foscarini.com

Foscarini Spazio Brera
via Fiori Chiari 28 /
via Pontaccio 19
20121 / Milano / Italy
T +39 02 870 71320
spaziobrera@foscarini.com

Foscarini Spazio Soho
20 Greene Street, New York
NY /10013 / USA
T +1 212 257 4412
spaziosoho@foscarini.com

Azienda certificata
UNI EN ISO 9001
UNI EN ISO 14001

edition 11.2016

Photography:
Massimo Gardone / Azimut.Photo
Maria Giulia Giorgiani
Jeremias Morandell
Andrea Garuti

made and printed in Italy
Grafiche GFP

foscarini.com





Foscarini SpA

via delle Industrie 27
30020 Marcon / Venezia / Italy
T +39 041 595 3811
F +39 041 595 3820
foscarini@foscarini.com
foscarini.com

