



Tecnico — 2017  
*Tavolo, Terra,  
Sospensione, Soffitto,  
Parete, Esterno.*



**FOSCARINI**





Tecnico — 2017  
Europe  
Valid from 1<sup>st</sup> January 2017

**FOSCARINI**





## Index

<b>Tavolo</b> →				
	<u>Anisha</u> → p. 014	<u>Behive</u> → p. 015	<u>Binic</u> → p. 018	<u>Birdie + Metal</u> → p. 016-017

				
<u>Buds 1 - 2 - 3</u> → p. 019	<u>Caboche</u> → p. 020	<u>Doll</u> → p. 021	<u>Esa</u> → p. 022	<u>Gregg</u> → p. 023

				
<u>Kurage</u> → p. 024	<u>Lumiere + Lumiere 25<sup>th</sup></u> → p. 025-027	<u>Lumiere xxl + xxs</u> → p. 028	<u>Magneto</u> → p. 029	<u>Plass media</u> → p. 030

				
<u>Poly Gregg</u> → p. 031	<u>Rituals + xl</u> → p. 032	<u>Tress</u> → p. 033	<u>Twiggy xl</u> → p. 034	<u>Uto</u> → p. 035

<b>Terra</b> →				
	<u>Yoko</u> → p. 036	<u>Aplomb</u> → p. 040	<u>Birdie</u> → p. 041	<u>Caboche</u> → p. 042



Index



Colibri  
→ p. 043



Giga-Lite  
→ p. 044



Gregg  
→ p. 045



Havana  
→ p. 046



Lightwing  
→ p. 047



Lumiere xxl  
→ p. 048



Magneto  
→ p. 049



Mite  
→ p. 050



Orbital  
→ p. 051



Stewie  
→ p. 052



Tress  
→ p. 053



Tress Stilo  
→ p. 054

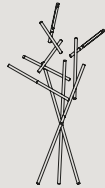

Tuereg  
→ p. 055

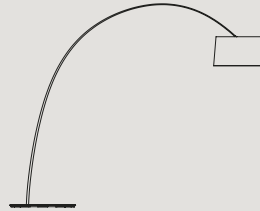

Twice as Twiggy  
→ p. 056

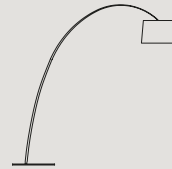

Twiggy  
→ p. 057



Twiggy lettura  
→ p. 058



Allegretto  
→ p. 062



Allegro  
→ p. 063

Sospensione →

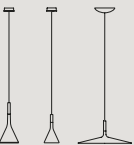

Aplomb  
+ mini + large  
→ p. 064-066



Behive  
→ p. 067



Big Bang + L + XL  
→ p. 068



Birdie  
→ p. 072



Buds  
→ p. 070

Index

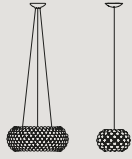

Caboche grande  
+ media + piccola  
→ p. 073-075



Caiigo  
→ p. 076



Chouchin + mini  
+ reverse  
→ p. 077-080



Giga-Lite  
→ p. 084



Gregg  
→ p. 082



Havana  
→ p. 085

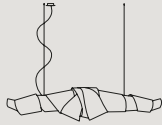

Jamaica  
→ p. 086



Le Soleil  
→ p. 087

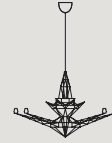

Lightweight  
→ p. 088



Maki  
→ p. 089



New Buds  
→ p. 090



O-space  
→ p. 091



Planet  
→ p. 092



Plass grande  
+ media  
→ p. 093

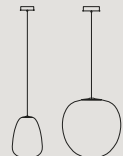

Rituals + Rituals xl  
→ p. 096

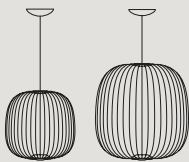

Spokes  
+ Spokes 2 large  
→ p. 095



Supernova  
→ p. 098



Tartan  
→ p. 099



Tite  
→ p. 100

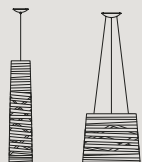

Tress + grande  
→ p. 101-102



Tress stilo  
→ p. 104

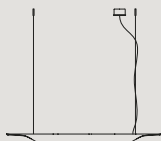

Troag  
→ p. 105



Tropico  
→ p. 106



Twice as Twiggy  
→ p. 107



Twiggy  
→ p. 108

## Index



Uto  
→ p. 109



Wave  
→ p. 110



Bahia + Bahia mini  
→ p. 122

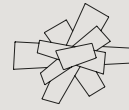

Big Bang  
→ p. 123

## Soffitto →

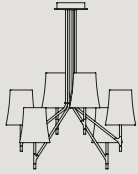

Birdie 1 - 3 - 6 - 9  
→ p. 124



Blob S  
→ p. 126



Caboche  
→ p. 127



Circus  
→ p. 128



Ellepi  
→ p. 129

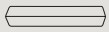

Falena  
→ p. 130



Folio  
→ p. 131



Gregg  
→ p. 132



Lumiere xxl+ xxs  
→ p. 133

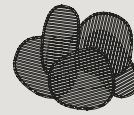

Nuage  
→ p. 134



Rituals  
→ p. 135

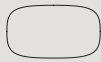

Tivu  
→ p. 136



Twiggy  
→ p. 137

## Parete →



Aplomb  
→ p. 140



Bahia + Bahia mini  
→ p. 141

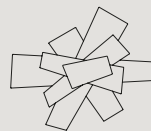

Big Bang  
→ p. 142

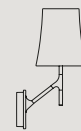

Birdie  
→ p. 143

## Index



Bit  
→ p. 144



Blob S  
→ p. 145

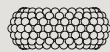

Caboche  
→ p. 146



Circus  
→ p. 147



Double  
→ p. 148



Ellepi  
→ p. 149

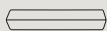

Falena  
→ p. 150

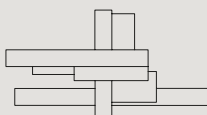

Fields  
→ p. 151



Flip  
→ p. 152



Folio  
→ p. 153



Gregg  
→ p. 154



Havana  
→ p. 155



Innerlight  
→ p. 156



Kite  
→ p. 157



Lake  
→ p. 158

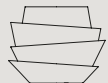

Le Soleil  
→ p. 159



Lumiere xxi + xxs  
→ p. 160

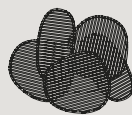

Nuage  
→ p. 161



Rituals  
→ p. 162



Tivu  
→ p. 163



Tress  
→ p. 164



Tutù  
→ p. 165

## Index

### Esterno →



Gregg outdoor  
sospensione  
→ p. 171



Havana outdoor  
sospensione  
→ p. 172



Uto  
→ p. 173



Gregg outdoor  
terra  
→ p. 168



Havana outdoor  
terra  
→ p. 169



Solar outdoor  
→ p. 170

### Accessori →



Kit  
decentramento  
→ p. 117



Packing  
→ p. 174



INFO  
→ p. 181



Rosone  
tondo  
→ p. 112

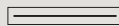

Rosone  
lineare L 90  
→ p. 112



Rosone  
lineare L 135  
→ p. 113

## Legenda



### LED

It marks the models with integrated LED included in the lamp, which is the result of Foscarini designing and engineering.



### ENEC

The label ENEC (Electrical Certification concerning European Standard) is a voluntary label granted by third organizations. It certifies that a product complies with the EN 60598 standards and has been designed and manufactured by companies with an approved UNI EN ISO 9001 quality control system.



Declares that the manufacturer produces light fittings which comply with the requirements of the EN 60598.



### Classe I

Class I° luminaire: it's necessary to connect the device to the yellow/green protective conductor (earthing).



### Classe II

Light fittings whose safety is guaranteed only by the double and/or reinforced insulation of all parts, with no earth.



Luminaire suitable for installation on normally inflammable surfaces.



### IP Protection Degree

IP20: protected against the penetration of solid objects greater than 12 mm and non protected against liquids.  
IP44: protected against the penetration of solid objects greater than 1 mm and protected against splashing water.  
IP65: dust-tight and protected against water jets.

### Energy efficiency classes

The energy efficiency classes for light appliances set out by EU regulation no. 874/2012 are calculated on the basis of the Energy Efficiency Index (EEI) and range between A++ (maximum efficiency) and E (minimum efficiency).

### Note:

\*

The dimmer could cause flickering of the light in case of use of a bulb with a lower wattage than the minimum indicated. It is not possible to guarantee the proper functioning of the dimmer with LED retrofit bulbs or compact Fluo bulbs with integrated power supply.

### Special colours:

it shows the possibility to order the lamps in a different color than the standard one (generally in the lampshade);  
minimum quantity, price and lead time on request.

### Azienda certificata

UNI EN ISO 9001  
UNI EN ISO 14001



### CSQ - IQNET

The CSQ-IQNET label is valid all over the world. It certifies that Foscarini runs a quality management system which complies with the UNI EN ISO 9001:2008 standard, to guarantee a high quality level for what concerns project, development, production and distribution of its products.



### CSQ ECO

*This label is valid all over the world.* It certifies that Foscarini runs an environmental management system which complies with the UNI EN ISO 14001:2004 standard in order to guarantee company's commitment to continual improvement of its environmental performances.

## Excerpt from sales conditions

1. Our prices are net ex works.
2. The prices include: carton packaging, transformers for low tensions. Prices do not include bulbs, if not differently stated.
3. The prices here contained refer to materials complying with the technical standards of the market this price list is meant for. Any request for material complying with other standards shall be quoted separately.
4. Goods are carefully inspected and accurately packed before shipment, Foscarini Spa therefore declines any liability for transport damages.
5. The goods are dispatched at the buyer's risk, even if sent free domicile.
6. Claims must be notified by registered mail addressed to our head offices within 3 days from receipt of the goods.
7. Any litigation falls within cognisance of Venice Italy Law-Court.
8. Dimensions and colours indicated have a tolerance due to the characteristic handwork of materials.
9. This price list can be subject to alteration without any notice.
10. Products images and configurations may vary from price book, catalogues and website from the actual merchandise, including but not limited to cords, cables, color, price, dimension, descriptions, details, dimmer.
11. Foscarini reserves the property of the goods until full payment of the same.
12. Prices are expressed in Euro.
13. This price list replaces any previous one.

# iFoscarini app



**iFoscarini** an app designed for all design enthusiasts who wish to customise their surroundings with the unmistakable personality of Foscarini models.

With captivating and emotional graphics and extremely user-friendly it allows users to insert lamps in rooms and settings which are caught on camera each time or picked from an archive of pictures. Available on the Apple Store and Play Store the iFoscarini app is a very effective tool that is extremely simple to use.

## Social media

Foscarini is present on all the main social networks with systems and languages suited to each individual channel and type of user:

- **Facebook** to create and maintain public relations, communicate news and projects, share news, images and films;
- **Instagram** to view projects and stimulate users to create images with Foscarini models.
- **Twitter** publicise events, initiatives, news and links in brief, high impact messages;
- **Pinterest** to share images of Foscarini models and initiatives, subdividing them into theme boards;
- **LinkedIn** to create and maintain relationships with sector operators and share professional contents





# foscarini.com



Packed with content, the [www.foscarini.com](http://www.foscarini.com) website keeps you up-to-date on our products, events and cultural initiatives at all times. The Video Stories section gives you the chance to find out about the concept and development of some of the most important Foscarini products. Information on the company, detailed technical data sheets for all models, assembly instructions, 2D and 3D designs as well as photometric curves can all be downloaded.

# myFoscarini



With the same spirit that provides new ideas in lighting design, Foscarini creates its own more efficient programs for customer and partner communication, for instance, **myFoscarini**, a proprietary it platform, an absolutely innovative, highly flexible and transparent tool providing customers with complete information and full range of functions. With just a few clicks in my foscarini you can:

- check the availability of lamps and the shipping date
- Enter your orders, reserving lamps directly from Foscarini's central system

- track your order status
  - consult sale conditions;
  - download admin documents such as transport documents and invoices;
  - prepare a quotation;
  - download: images, logos, PDF and excel price lists assembly instructions, certifications and energy labels.
- And all this 7 days a week, 24 hours a day.  
If you haven't registered yet request your password from Foscarini Customer Care.



Tavolo, *Table*014 **Anisha**015 **Behive**018 **Binic**016 **Birdie**017 **Birdie Metal**019 **Buds**020 **Caboche**021 **Doll**022 **Esa**023 **Gregg**024 **Kurage**025 - 026 **Lumiere**027 **Lumiere 25<sup>th</sup>**028 **Lumiere xxl  
+ xxs**029 **Magneto**030 **Plass media**031 **Poly Gregg**032 **Rituals**033 **Tress**034 **Twiggy xl**035 **Uto**036 **Yoko**

## Anisha

Lievore Altherr Molina,  
2011



	energy cl.	colours	code	vat excluded
<i>Anisha grande</i>	A <sup>+</sup>	bianco	213001R1 10	353,00
		rosso *	213001R1 63	
<i>Anisha piccola</i>	A <sup>+</sup>	bianco	2130012R1 10	282,00
		rosso *	2130012R1 63	

\* limited stock available

Injection moulded ABS

### *Anisha grande*

LED included  
Power LED 4,5W 3000° K  
400 lm CRI>80 88 lm/W  
Integrated touch dimmer

### *Anisha piccola*

LED included  
Power LED 3,4W 3000° K  
300 lm CRI>80 88 lm/W  
Integrated touch dimmer

Colours: bianco,



rosso\*

limited stock available



Weight:

*Anisha grande*  
net kg 0,70

*Anisha piccola*  
net kg 0,40

With personalized packaging



Tecnico — 2017

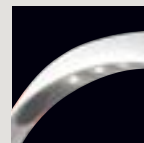
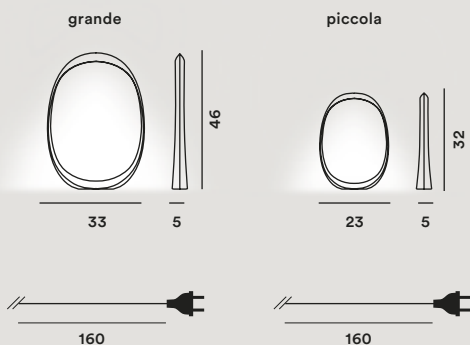

**Behive**

Werner Aisslinger, 2011



Batch-dyed ABS,  
polycarbonate and coated  
metal

Halo or LED retrofit  
1x150W E27  
Dimmer included  
minimum Halo bulb output  
40W, with LED retrofit bulbs  
use dimmer only at full  
power



 IP 20

	energy cl.	colours	code	vat excluded
<i>Behive</i>	A <sup>+</sup> , A, C	bianco	203001 10	420,00
<b>Spare parts:</b>				
<i>Lampshade Behive</i>		bianco	203S00 10	192,00
<i>Protection glass</i>			203V01/I	50,00
<i>Dimmer</i>			LTD FD TR/I	29,00

Colours: bianco



Special colours  
on request

Weight:  
net kg 3,70

Halo, LED retrofit  
light bulbs not included  
→ specifications p. 182

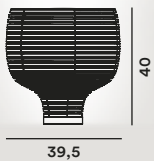

collection →



p. 067



**Birdie**

Ludovica + Roberto  
Palomba, 2011



Polycarbonate, varnished steel and metal

*Birdie grande on/off*  
LED retrofit or Fluo  
1x25W E27  
Halo 1x150W E27

*Birdie grande with integrated touch dimmer*  
Halo or dimmable LED  
retrofit 1x150 E27 minimum  
Halo bulb output 40W

*Birdie piccola on/off*  
LED retrofit or Fluo  
1x20W E27  
Halo 1x70W E27

*Birdie piccola with integrated touch dimmer*  
Dimmable LED retrofit or  
Halo 1x70W E27 minimum  
Halo bulb output 40W

IP 20

	energy cl.	colours	code	vat excluded
<i>Birdie grande on/off</i>	A+, A, C	bianco	221001S 10	277,00
		grigio	221001S 25	
		arancio	221001S 53	
		amaranto	221001S 65	
<i>Birdie grande with touch dimmer</i>	A+, A, C	bianco	221001 10	336,00
		grigio	221001 25	
		arancio	221001 53	
		amaranto	221001 65	
<i>Birdie piccola on/off</i>	A+, A, C	bianco	2210012 10	235,00
		grigio	2210012 25	
		arancio	2210012 53	
		amaranto	2210012 65	
<i>Birdie piccola with touch dimmer</i>	A+, A, C	bianco	2210012DM 10	287,00
		grigio	2210012DM 25	
		arancio	2210012DM 53	
		amaranto	2210012DM 65	
<b>Spare parts:</b>				
<i>Lampshade Birdie grande</i>		bianco	221S00 10	66,00
		grigio	221S00 25	
		arancio	221S00 53	
		amaranto	221S00 65	
<i>Lampshade Birdie piccola</i>		bianco	221S002 10	46,00
		grigio	221S002 25	
		arancio	221S002 53	
		amaranto	221S002 65	

Colours: bianco, grigio, arancio, amaranto



Special colours on request

Weight:  
*Birdie grande*  
net kg 4,00

*Birdie piccola*  
net kg 2,00

Halo, Fluo, LED retrofit light bulbs not included  
→ specifications p. 182

Tecnico — 2017

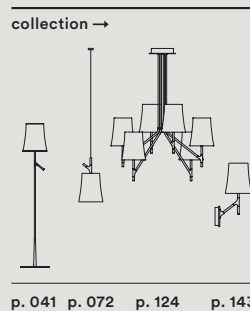
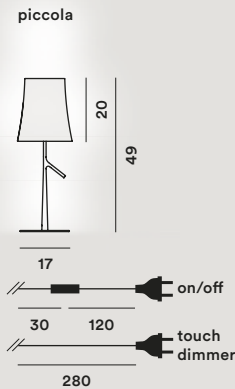
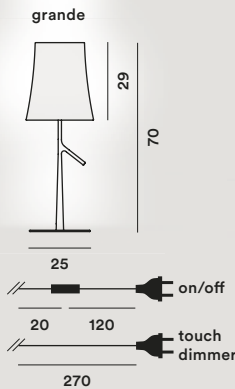

## Birdie Metal

Ludovica + Roberto  
Palomba, 2014



	energy cl.	colours	code	vat excluded
<i>Birdie Metal grande</i>	A+, A	cromo nero	221001SR1 78	458,00
		rame	221001SR1 57	
<i>Birdie Metal piccola</i>	A+, A	cromo nero	2210012R1 78	357,00
		rame	2210012R1 57	
<b>Spare parts:</b>				
<i>Lampshade Birdie Metal grande</i>		cromo nero	221S00 78	92,00
		rame	221S00 57	
<i>Lampshade Birdie Metal piccola</i>		cromo nero	221S002 78	65,00
		rame	221S002 57	

Metallized polycarbonate  
and metallized steel

*Birdie Metal grande*  
LED retrofit or Fluo  
1x25W E27

*Birdie Metal piccola*  
LED retrofit or Fluo  
1x20W E27

With personalized packaging

IP 20

Colours: cromo nero, rame



Weight:

*Birdie Metal grande*  
net kg 4,00

*Birdie Metal piccola*  
net kg 2,00

Fluo, LED retrofit light  
bulbs not included  
→ specifications p. 182

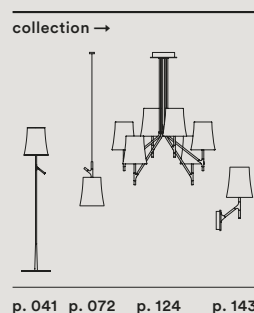
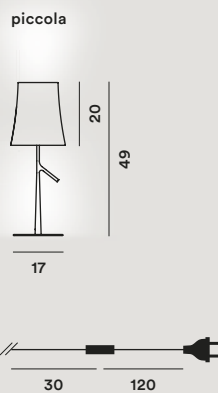
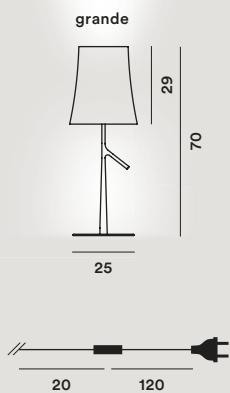

# 018 Tavolo, Table

## Binic

Ionna Vautrin, 2010



	energy cl.	colours	code	vat excluded
<i>Binic</i>	A+, A	bianco	20000110	122,00
		antracite	20000127	
		verde acqua	20000142	
		giallo	20000155	
		rosa	20000161	
		blu	20000187	

batch-dyed ABS and polycarbonate

LED retrofit or Fluo  
1x12W E 14

With personalized packaging

☐ ▽ CE IP 20

Colours: bianco, rosa, verde acqua, blu, giallo, antracite

Weight:  
net kg 0,60

Fluo, LED retrofit light bulbs not included  
→ specifications p. 182



Tecnico — 2017

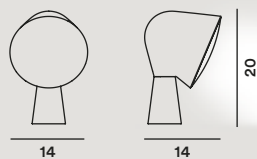



## Buds

Rodolfo Dordoni, 2016



Blown glass and PMMA

LED retrofit or Fluo  
max 1x23W E27  
Ø 9-12 cm

Recommended white globe  
bulb  
Ø 12 cm for Buds 1-2  
Ø 9 cm for Buds 3

CE IP 20

	energy cl.	colours	code	vat excluded
<b>Buds 1</b>	A <sup>+</sup> , A, C	bianco caldo	278011 12	706,00
		marrone	278011 54	
<b>Buds 2</b>		bianco caldo	278012 12	739,00
		grigio	278012 24	
<b>Buds 3</b>		bianco caldo	278013 12	668,00
		verde	278013 40	
<b>Spare parts:</b>				
<b>Glass Buds 1</b>		bianco caldo	278S001 12	334,00
		marrone	278S001 54	
<b>Glass Buds 2</b>		bianco caldo	278S002 12	367,00
		grigio	278S002 54	
<b>Glass Buds 3</b>		bianco caldo	278S003 12	304,00
		verde	278S003 54	

### Colours:

**Buds 1** bianco caldo,  
marrone.

**Buds 2** bianco caldo,  
grigio.

**Buds 3** bianco caldo,  
verde bambù



### Weight:

**Buds 1**  
net kg 4,80

**Buds 2**  
net kg 5,80

**Buds 3**  
net kg 4,20

Fluo, LED retrofit light  
bulbs not included  
→ specifications p. 182

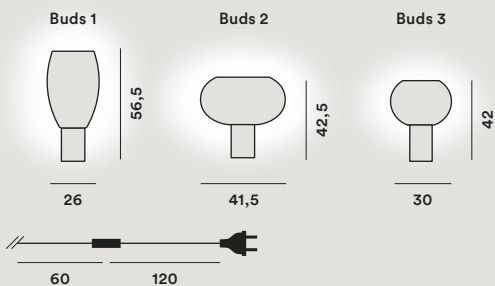

collection →



p. 70



## Caboche

Patricia Urquiola con  
Elia Gerotto, 2005



PMMA, blown glass and  
coated aluminium

Halo or LED retrofit  
1x48W G9

Dimmer included  
minimum Halo bulb output  
40W, with LED retrofit bulbs  
use dimmer only at full  
power

☐ ▽ CE IP 20

	energy cl.	colours	code	vat excluded
<b>Caboche</b>	A <sup>+</sup> , A, C	trasparente	138012 16	504,00
		giallo oro	138012 52	
<b>Spare parts:</b>				
<b>Set sphere Caboche tavolo</b>		trasparente	138S002 16	160,00
		giallo oro	138S002 52	
<b>Kit 10 prongs 3 sphere Caboche tavolo</b>			138KIT 10P3	24,00
<b>Kit 10 prongs 4 sphere Caboche tavolo</b>			138KIT 10P4	24,00
<b>Kit 3+3 prongs 3 + 4 sphere Caboche tavolo</b>			138KIT2-R2	18,00
<b>Glass Caboche tavolo</b>			138V012/I	42,00
<b>Dimmer</b>			LTD FD TR/I	29,00

Colours: trasparente,  
giallo oro

Weight:  
net kg 5,30

Halo, LED retrofit  
light bulbs not included  
→ specifications p. 182

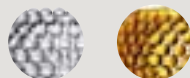

Special colours  
on request

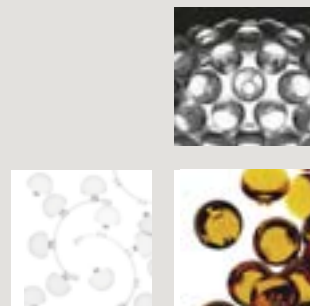
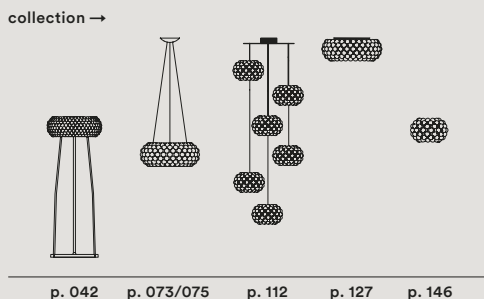
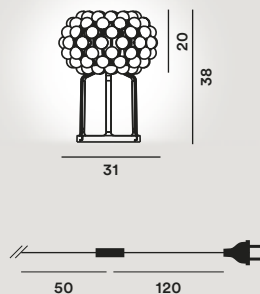

**Doll**

Ionna Vautrin, 2012



Blown glass, batch-dyed  
ABS and polycarbonate

LED retrofit or Fluo  
1x12W E14

With personalized packaging

☐ ▽ CE IP 20

	energy cl.	colours	code	vat excluded
<i>Doll</i>	A <sup>+</sup> , A	grigio	245001 25	134,00
		verde	245001 40	
		avorio	245001 50	
		rosso	245001 63	
<b>Spare parts:</b>				
<i>Glass Doll</i>			245S00 10	63,00

Colours: avorio, grigio,  
verde, rosso

Weight:  
net kg 0,70

Fluo, LED retrofit light  
bulbs not included  
→ specifications p. 182

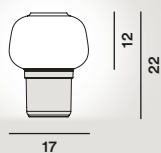

## 022 Tavolo, Table

### Esa

Lievore Altherr Molina,  
1996



Blown glass and polished  
aluminium

*Esa grande*  
LED retrofit or Fluo  
1x20W E27  
Halo 1x77W E27

*Esa piccola*  
Halo or LED retrofit  
1x40W G9  
Dimmer included  
minimum Halo bulb output  
10W, with LED retrofit bulbs  
use dimmer only at full power

☐ ▽ CE IP 20

	energy cl.	colours	code	vat excluded
<i>Esa grande</i>	A <sup>+</sup> , A, B, C	bianco	075001-R2 11	585,00
<i>Esa piccola</i>	A <sup>+</sup> , A, C	bianco	0750012 11	329,00

#### Spare parts:

<i>Glass Esa grande</i>	bianco	075S00 11	267,00
<i>Glass Esa piccola</i>	bianco	075S002 11	146,00
<i>Dimmer Esa piccola</i>		LTD 1002/I	44,00

Colours: bianco



Special colours  
on request

Weight:  
*Esa grande*  
net kg 3,20

*Esa piccola*  
net kg 2,30

Halo, Fluo, LED retrofit  
light bulbs not included  
→ specifications p. 182

Tecnico — 2017

grande

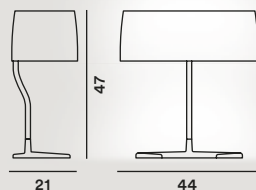

piccola

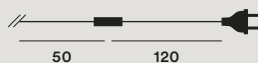
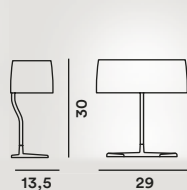

**Gregg**

Ludovica + Roberto  
Palomba, 2007



Blown acid-etched glass and coated metal

**Gregg grande**  
Led retrofit or Fluo  
1x25W E27  
Dimmer included  
Halo or dimmable LED  
retrofit 1x205W E27  
minimum Halo bulb output  
60W

**Gregg media**  
Led retrofit or Fluo  
1x20W E27  
Dimmer included  
Halo or s 1x150W E27  
minimum Halo bulb output  
60W

**Gregg piccola**  
Led retrofit or Halo  
1x20W G9  
Dimmer included  
minimum Halo bulb output  
10W, with LED retrofit bulbs  
use dimmer only at full  
power



	energy cl.	colours	code	vat excluded
<i>Gregg grande on/off</i>	A+, A, C	bianco	1680011S 10	507,00
<i>Gregg grande w. dimmer</i>	A+, A, C		1680011 10	526,00
<i>Gregg media on/off</i>	A+, A, C	bianco	168001S 10	300,00
<i>Gregg media w. dimmer</i>	A+, A, C		168001 10	319,00
<i>Gregg piccola on/off</i>	A+, A, C	bianco	1680012S 10	145,00
<i>Gregg piccola w. dimmer</i>	A+, A, C		1680012 10	175,00

**Spare parts:**

<i>Glass Gregg grande</i>	bianco	168S001 10	318,00
<i>Dimmer</i>		LTD RONDO T/I	42,00
<i>Glass Gregg media</i>	bianco	168S00 10	172,00
<i>Dimmer</i>		LTD FD TR/I	29,00
<i>Glass Gregg piccola</i>	bianco	168S00210	59,00
<i>Dimmer</i>		LTD 1002/I	44,00

Colours: bianco



Weight:  
**Gregg grande**  
net kg 6,80

**Gregg media**  
net kg 3,30

**Gregg piccola**  
net kg 0,60

Halo, Fluo, LED retrofit  
light bulbs not included  
→ specifications p. 182

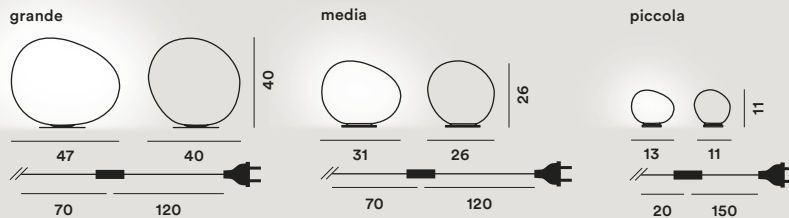

collection →

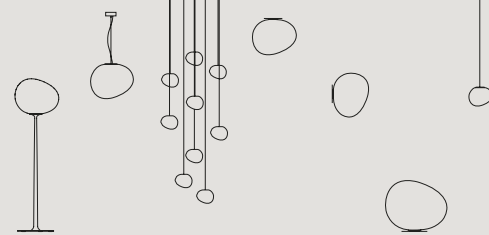

p. 045 p. 082 p. 112 p. 132 p. 154 p. 168 p. 171



## 024 Tavolo, Table

### Kurage

Nichetto + Nendo, 2015



Washi paper and ashwood

LED retrofit or Fluo  
1x12W E27

☐ ▽ CE IP 20

	energy cl.	colours	code	vat excluded
<i>Kurage</i>	A+, A	bianco	25800110	462,00
<b>Spare parts:</b>				
<i>Lampshade Kurage</i>		bianco	258S0010	168,00

Colours: bianco



Weight:  
net kg 0,70

Fluo, LED retrofit light  
bulbs not included  
→ specifications p. 182

Tecnico — 2017

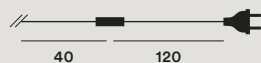
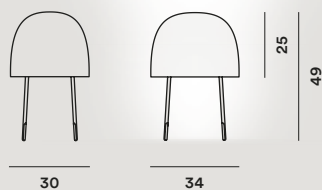

**Lumiere grande**

Rodolfo Dordoni, 1990



Blown glass and polished  
aluminium or black chrome

Halo or LED retrofit  
2x48W G9  
Dimmer included  
minimum Halo bulb output  
40W with dimmer, with LED  
retrofit bulbs use dimmer  
only at full power

IP 20

	energy cl.	colours	code	vat excluded
<b>Lumiere grande on/off</b>	A+, A, C	alluminio/bianco	026001R2 11	429,00
		all./bianco caldo	026001R2 12	487,00
		all./turchese	026001R2 32	
		all./ciliegia	026001R2 62	
<b>Lumiere grande on/off</b>	A+, A, C	cromo nero/bianco	026011R2 11	429,00
		c. nero/bianco caldo	026011R2 12	487,00
		c. nero/turchese	026011R2 32	
		c. nero/ciliegia	026011R2 62	
<b>Lumiere grande on/off</b>	A+, A, C	champagne/bianco	026021R2 11	429,00
		cham./bianco caldo	026021R2 12	487,00
		cham./turchese	026021R2 32	
		cham./ciliegia	026021R2 62	
<b>Lumiere grande with dimmer</b>	A+, A, C	alluminio/bianco	026001R2 11 D	458,00
		all./bianco caldo	026001R2 12 D	516,00
		all./turchese	026001R2 32 D	
		all./ciliegia	026001R2 62 D	
<b>Lumiere grande with dimmer</b>	A+, A, C	cromo nero/bianco	026011R2 11 D	458,00
		c. nero/bianco caldo	026011R2 12 D	516,00
		c. nero/turchese	026011R2 32 D	
		c. nero/ciliegia	026011R2 62 D	
<b>Lumiere grande with dimmer</b>	A+, A, C	champagne/bianco	026021R2 11 D	458,00
		cham./bianco caldo	026021R2 12 D	516,00
		cham./turchese	026021R2 32 D	
		cham./ciliegia	026021R2 62 D	
<b>Spare parts:</b>				
<b>Glass Lumiere grande</b>		bianco	026S00 11	181,00
		bianco caldo	026S00 12	239,00
		turchese	026S00 32	
		ciliegia	026S00 62	
<b>Dimmer</b>			RLTD 1003	39,00

Glass colours:  
bianco, bianco caldo,  
ciliegia, turchese

Weight:  
net kg 2,40

Halo, LED retrofit  
light bulbs not included  
→ specifications p. 182

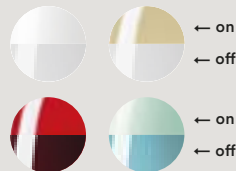

Frame colours:  
alluminio, cromo nero,  
champagne

collection →

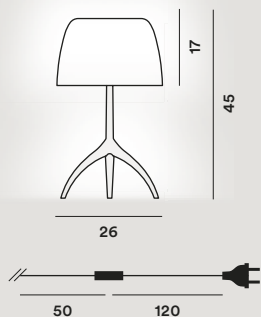

Special colours  
on request



**Lumiere piccola**

Rodolfo Dordoni, 1990



Blown glass and polished aluminium or varnished

Halo or LED retrofit  
1x42W G9  
Dimmer included  
minimum Halo bulb output  
40W with dimmer, with LED  
retrofit bulbs use dimmer  
only at full power



	energy cl.	colours	code	vat excluded
<i>Lumiere piccola on/off</i>	A+, A, C	alluminio/bianco	0260012R2 11	294,00
		all./bianco caldo	0260012R2 12	349,00
		all./turchese	0260012R2 32	
		all./ciliegia	0260012R2 62	
<i>Lumiere piccola on/off</i>	A+, A, C	cromo nero/bianco	0260112R2 11	294,00
		c. nero/bianco caldo	0260112R2 12	349,00
		c. nero/turchese	0260112R2 32	
		c. nero/ciliegia	0260112R2 62	
<i>Lumiere piccola on/off</i>	A+, A, C	champagne/bianco	0260212R2 11	294,00
		cham./bianco caldo	0260212R2 12	349,00
		cham./turchese	0260212R2 32	
		cham./ciliegia	0260212R2 62	
<i>Lumiere piccola with dimmer</i>	A+, A, C	alluminio/bianco	0260012R2 11D	323,00
		all./bianco caldo	0260012R2 12D	378,00
		all./turchese	0260012R2 32D	
		all./ciliegia	0260012R2 62D	
<i>Lumiere piccola with dimmer</i>	A+, A, C	cromo nero/bianco	0260112R2 11D	323,00
		c. nero/bianco caldo	0260112R2 12D	378,00
		c. nero/turchese	0260112R2 32D	
		c. nero/ciliegia	0260112R2 62D	
<i>Lumiere piccola with dimmer</i>	A+, A, C	champagne/bianco	0260212R2 11D	323,00
		cham./bianco caldo	0260212R2 12D	378,00
		cham./turchese	0260212R2 32D	
		cham./ciliegia	0260212R2 62D	

**Spare parts:**

<i>Glass Lumiere piccola</i>	bianco	026S002R 11	103,00
	bianco caldo	026S002R 12	158,00
	turchese	026S002R 32	
	ciliegia	026S002R 62	
<i>Dimmer</i>		RLTD 1003	39,00

Glass colours:  
bianco, bianco caldo,  
ciliegia, turchese

Weight:  
net kg 1,10

Halo, LED retrofit  
light bulbs not included  
→ specifications p. 182

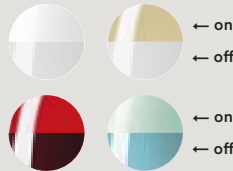

Frame colours:  
alluminio, cromo nero,  
champagne

collection →



Special colours  
on request



p. 027

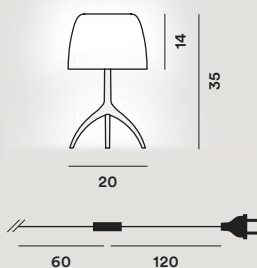



**Lumiere 25<sup>th</sup>**Rodolfo Dordoni,  
1990/2015Blown mirrored glass and  
polished or varnished  
aluminium**Lumiere 25<sup>th</sup> grande**Halo or LED retrofit 2x48W G9  
Dimmer included  
minimum Halo bulb output 40W with  
dimmer, with LED retrofit bulbs use  
dimmer only at full power**Lumiere 25<sup>th</sup> piccola**Halo or LED retrofit 1x42W G9  
Dimmer included  
minimum Halo bulb output 40W with  
dimmer, with LED retrofit bulbs use  
dimmer only at full power

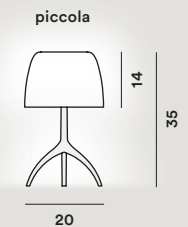
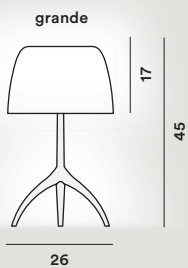

	energy cl.	colours	code	vat excluded
<b>Lumiere 25<sup>th</sup> grande</b>	A <sup>+</sup> , A, C	alluminio/25 <sup>th</sup>	026001R2 30	647,00
		cromo nero/25 <sup>th</sup>	026011R2 30	
		champagne/25 <sup>th</sup>	026021R2 30	
<b>Lumiere 25<sup>th</sup> grande with dimmer</b>	A <sup>+</sup> , A, C	alluminio/25 <sup>th</sup>	026001R2 30 D	676,00
		cromo nero/25 <sup>th</sup>	026011R2 30 D	
		champagne/25 <sup>th</sup>	026021R2 30 D	
<b>Lumiere 25<sup>th</sup> piccola</b>	A <sup>+</sup> , A, C	alluminio/25 <sup>th</sup>	0260012R2 30	492,00
		cromo nero/25 <sup>th</sup>	0260112R2 30	
		champagne/25 <sup>th</sup>	0260212R2 30	
<b>Lumiere 25<sup>th</sup> piccola with dimmer</b>	A <sup>+</sup> , A, C	alluminio/25 <sup>th</sup>	0260012R2 30D	521,00
		cromo nero/25 <sup>th</sup>	0260112R2 30D	
		champagne/25 <sup>th</sup>	0260212R2 30D	

**Spare parts:**

<b>glass Lumiere 25<sup>th</sup> grande</b>	026S00 30	399,00
<b>glass Lumiere 25<sup>th</sup> piccola</b>	026S002R 30	301,00
<b>Dimmer</b>	RLTD 1003	39,00

**Glass colours:**

specchio trasparente

**Weight:****Lumiere 25<sup>th</sup> grande**  
net kg 2,40**Lumiere 25<sup>th</sup> piccola**  
net kg 1,10**Frame colours:**alluminio, cromo nero,  
champagne

collection →



p. 025

p. 026

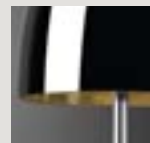

**Lumiere xxl + xxs**

Rodolfo Dordoni, 2009



Blown glass and lacquered aluminium

**Lumiere xxl**  
Halo or LED retrofit 4x33W G9  
Dimmer included  
minimum Halo bulb output 40W with dimmer, with LED retrofit bulbs use dimmer only at full power

**Lumiere xxs**  
Halo or LED retrofit 1x42W G9  
Dimmer included  
minimum Halo bulb output 40W with dimmer, with LED retrofit bulbs use dimmer only at full power



Lumiere xxl

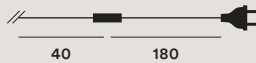
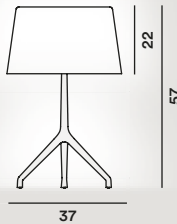

Lumiere xxs

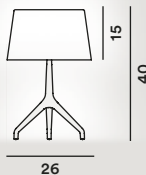

	energy cl.	colours	code	vat excluded
<b>Lumiere xxl</b>	A+, A, C	alluminio/bianco	191001A 11	748,00
		alluminio/grigio	191001A 24	
		alluminio/marrone	191001A 55	
		cromo nero/bianco	191001C 11	
		cromo nero/grigio	191001C 24	
		cr. nero/marrone	191001C 55	
<b>Lumiere xxs</b>	A+, A, C	alluminio/bianco	1910012A 11	491,00
		alluminio/grigio	1910012A 24	
		alluminio/marrone	1910012A 55	
		cromo nero/bianco	1910012C 11	
		cromo nero/grigio	1910012C 24	
		cr. nero/marrone	1910012C 55	

Spare parts:

<b>Glass Lumiere xxl</b>	bianco	191S001 11	335,00
	grigio	191S001 24	
	marrone	191S001 55	
<b>Glass Lumiere xxs</b>	bianco	191S002 11	204,00
	grigio	191S002 24	
	marrone	191S002 55	
<b>Dimmer</b>		RLTD 1003	39,00

Glass colours:  
bianco, grigio freddo,  
marrone freddo



Weight:  
**Lumiere xxl**  
net kg 5,50

**Lumiere xxs**  
net kg 1,80

Halo, LED retrofit  
light bulbs not included  
→ specifications p. 182

Frame colours:  
alluminio, cromo nero



Special colours  
on request

collection →

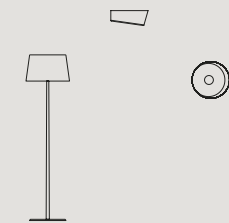

p. 048 p. 135 p. 160



**Magneto**

Giulio Iacchetti, 2011

**LED**

	energy cl.	colours	code	vat excluded
<b>Magneto</b>	A+	bianco	202001R2 10	311,00
		nero	202001R2 20	

Coated steel, ABS and super magnet made of "rare earth"

LED included  
Power LED 5W 2700° K  
475 lm CRI>80 95 lm/W

With personalized packaging

IP 20

Colours: bianco, nero



Special colours  
on request

Weight:  
net kg 1,30

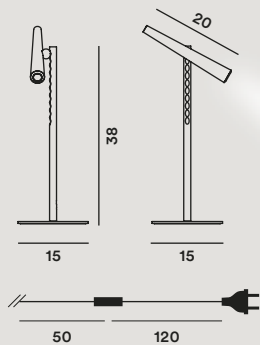

collection →



p. 049



**Plass media**

Luca Nichetto, 2015



	energy cl.	colours	code	vat excluded
<i>Plass media on/off</i>	A <sup>+</sup> , A, C	grigio	2240012 25	370,00
		azzurro	2240012 30	
<i>Plass media with dimmer</i>	A <sup>+</sup> , A, C	grigio	2240012D 25	391,00
		azzurro	2240012D 30	
<b>Spare parts:</b>				
<i>Lampshade Plass</i>		grigio	224S002 25	241,00
		azzurro	224S002 30	
<i>Dimmer</i>			LTD FD TR/I	29,00

Rotational moulded polycarbonate and steel

*Plass media on/off*  
LED retrofit or Fluo  
1x25W E27  
Halo 1x150W E27

*Plass media with dimmer*  
Halo or dimmable LED retrofit  
1x150W E27  
minimum Halo bulb output  
60W with dimmer



Colours: grigio, azzurro

Weight:  
net kg 4,00

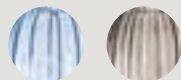

Halo, Fluo, LED retrofit  
light bulbs not included  
→ specifications p. 182

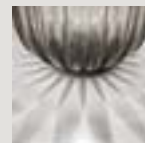
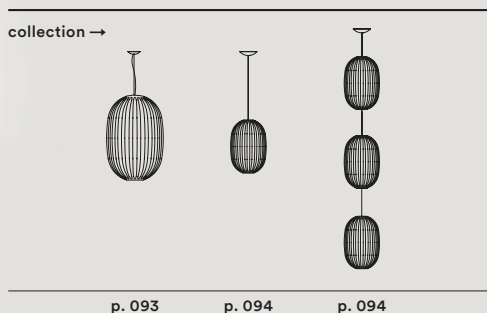
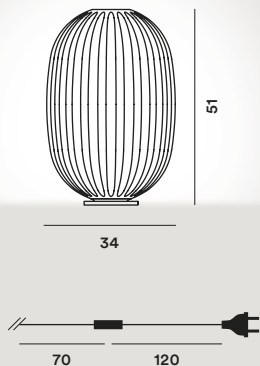

# Poly Gregg

Ludovica + Roberto  
Palomba, 2011



Rotational moulded  
polyethylene

*Poly Gregg X-large or grande*  
LED retrofit or Fluo  
1x25W E27

*Poly Gregg media*  
LED retrofit or Fluo  
1x15W E27

IP 20

	energy cl.	colours	code	vat excluded
<i>Poly Gregg X-large</i>	A <sup>+</sup> , A	bianco	2180030 10	353,00
<i>Poly Gregg grande</i>	A <sup>+</sup> , A	bianco	2180130 10	275,00
<i>Poly Gregg media</i>	A <sup>+</sup> , A	bianco	2180230 10	193,00
<b>Spare parts:</b>				
<i>Lampshade Poly Gregg X-large</i>		bianco	218S001 10	179,00
<i>Lampshade Poly Gregg grande</i>		bianco	218S00 10	101,00
<i>Lampshade Poly Gregg media</i>		bianco	218S002 10	63,00

Colours: bianco



Weight:  
*X-large*  
net kg 4,30

*grande*  
net kg 3,60

*media*  
net kg 1,60

Fluo, LED retrofit light  
bulbs not included  
→ specifications p. 182

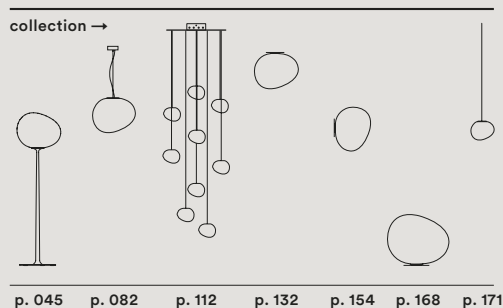
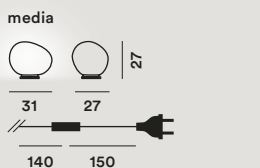
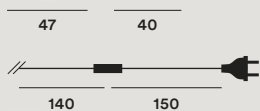
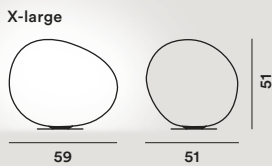

**Rituals + Rituals xl**

Ludovica + Roberto  
Palomba, 2012 - 2015



	energy cl.	colours	code	vat excluded
<i>Rituals 1 on/off</i>	A <sup>+</sup> , A, C	bianco	2440011 10	335,00
<i>Rituals 1 with dimmer</i>	A <sup>+</sup> , A, C	bianco	2440011D1 10	373,00
<i>Rituals 2 on/off</i>	A <sup>+</sup> , A, C	bianco	2440012 10	335,00
<i>Rituals 2 with dimmer</i>	A <sup>+</sup> , A, C	bianco	2440012D1 10	373,00
<i>Rituals 3 on/off</i>	A <sup>+</sup> , A, C	bianco	2440013 10	280,00
<i>Rituals 3 with dimmer</i>	A <sup>+</sup> , A, C	bianco	2440013D1 10	318,00

Blown engraved satin glass  
and coated metal

Colours: bianco

Weight:  
*Rituals 1*  
net kg 4,00

Halo, Fluo, LED retrofit  
light bulbs not included  
→ specifications p. 182

*1-2-3 on/off*  
LED retrofit or Fluo 1x15W E27  
Halo 1x105W E27



*Rituals 2*  
net kg 4,10

*1-2-3 with dimmer*  
Halo or dimmable LED  
retrofit 105W E27  
minimum Halo bulb output  
40W

*Rituals 3*  
net kg 1,60

*Rituals xl on/off*  
LED retrofit or Fluo 1x25W E27  
Halo 1x150W E27

*Rituals xl*  
net kg 6,60

*Rituals xl with dimmer*  
dimmable LED retrofit or  
Halo 1x150W E27  
minimum Halo bulb output  
60W

☐ ▽ CE ⚡ IP 20

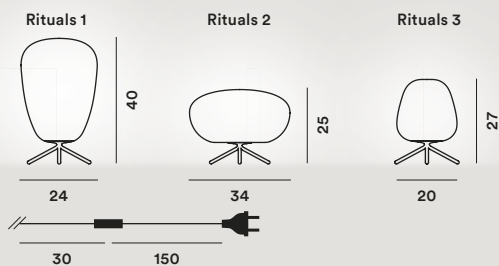

collection →

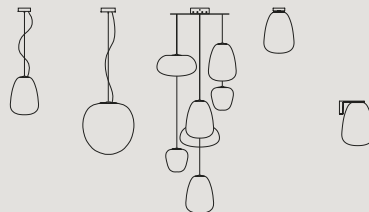

	energy cl.	colours	code	vat excluded
<i>Rituals xl on/off</i>	A <sup>+</sup> , A, C	bianco	2440014 10	487,00
<i>Rituals xl with dimmer</i>	A <sup>+</sup> , A, C	bianco	2440014D 10	506,00

## Spare parts:

<i>Glass Rituals 1</i>		bianco	244S001 10	222,00
<i>Glass Rituals 2</i>		bianco	244S002 10	222,00
<i>Glass Rituals 3</i>		bianco	244S003 10	167,00
<i>Glass Rituals XL</i>		bianco	244S004 10	315,00
<i>Dimmer</i>			LTD FD TR/I	29,00

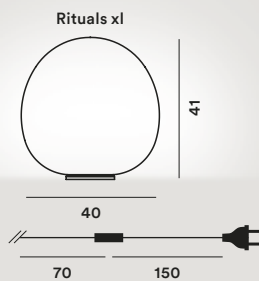

# 034 Tavolo, Table

## Tress

Marc Sadler, 2009



Varnished fibreglass-based composite material

**Tress**  
dimmable LED retrofit or Halo 1x100W GU10 PAR dimmer included  
minimum Halo bulb output 40W

**Tress mini**  
dimmable LED retrofit or Halo 1x75W GU10 PAR 20 dimmer included  
minimum Halo bulb output 40W

☐ ▽ CE IP 20

	energy cl.	colours	code	vat excluded
<b>Tress</b>	A <sup>+</sup> , A, C	bianco	182001 10	441,00
		nero	182001 20	
		cremisi	182001 67	
		greige	182001 25	
		indaco	182001 87	
<b>Tress mini</b>	A <sup>+</sup> , A, C	bianco	1820012 10	399,00
		nero	1820012 20	
		cremisi	1820012 67	
		greige	1820012 25	
		indaco	1820012 87	
<b>Spare parts:</b>				
<b>Lampshade Tress</b>		bianco	182S01 10	307,00
		nero	182S01 20	
		cremisi	182S01 67	
		greige	182S01 25	
<b>Lampshade Tress mini</b>		indaco	182S01 87	282,00
		bianco	182S0012 10	
		nero	182S0012 20	
		cremisi	182S0012 67	
		greige	182S0012 25	
<b>Dimmer</b>			LTD FD TR/I	29,00

Colours: bianco, nero, cremisi, greige, indaco

Weight:  
**Tress**  
net kg 3,20

Halo, LED retrofit light bulbs not included  
→ specifications p. 182

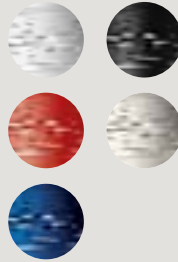

**Tress mini**  
net kg 1,40

Special colours on request

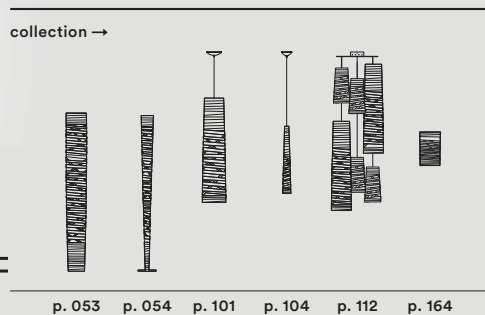
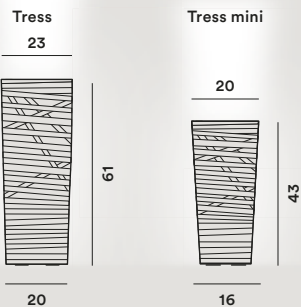

p. 053 p. 054 p. 101 p. 104 p. 112 p. 164





**Twiggy xl**

Marc Sadler, 2008



Varnished fibreglass-based composite material, polycarbonate and varnished metal

Halo or dimmable LED retrofit 3x150W E27  
Dimmer included minimum Halo bulb output 40W

☐ ▽ CE IP 20

	energy cl.	colours	code	vat excluded
<i>Twiggy xl</i>	A <sup>+</sup> , A, C	bianco	1590011 10	755,00
		nero	1590011 20	
<b>Spare parts:</b>				
<i>Lampshade Twiggy xl</i>		bianco	159S10 10	464,00
		nero	159S10 20	
<i>Dimmer</i>			LTD 5000TR/I	39,00

Colours: bianco, nero



Special colours on request

Weight:  
net kg 6,80

Halo, LED retrofit light bulbs not included  
→ specifications p. 182

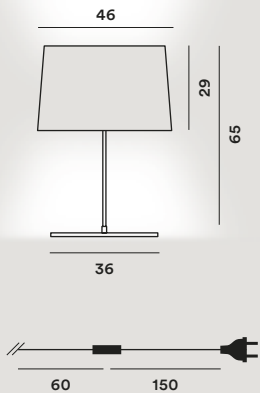

collection →



**Uto**

Lagranja Design, 2005



	energy cl.	colours	code	vat excluded
<i>Uto</i>	A <sup>+</sup> , A	bianco	142000 10	349,00
		giallo	142000 50	
		arancio	142000 53	

Thermoplastic elastomer and polycarbonate

LED retrofit or Fluo  
1x15W E27

Switch inside the flexible tube

IP 44

Colours: bianco, giallo, arancio



Weight:  
net kg 2,00

Fluo, LED retrofit  
light bulbs not included  
→ specifications p. 182

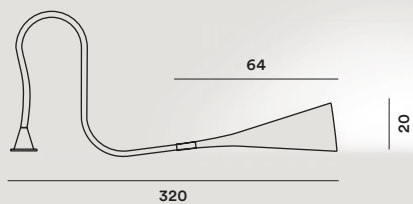

collection →

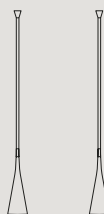

**Yoko**

Anderssen &amp; Voll, 2013



	energy cl.	colours	code	vat excluded
<b>Yoko</b>	A <sup>+</sup> , A	verde	239001 40	<b>259,00</b>
		arancio	239001 50	
		viola	239001 80	
<b>Spare parts:</b>				
<b>Lampshade Yoko</b>		verde	239S00 40	<b>134,00</b>
		arancio	239S00 50	
		viola	239S00 80	

PMMA / polycarbonate

LED retrofit or Fluo  
1x25W E27

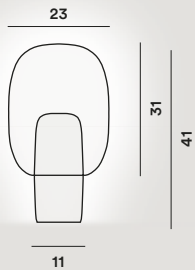
Colours: verde, arancio,  
violaWeight:  
net kg 2,00Fluo, LED retrofit  
light bulbs not included  
→ specifications p. 182



Terra, *Floor*

- |     |                           |     |                              |
|-----|---------------------------|-----|------------------------------|
| 040 | <b>Aplomb</b>             | 050 | <b>Mite</b>                  |
| 041 | <b>Birdie</b>             | 051 | <b>Orbital</b>               |
| 042 | <b>Caboche</b>            | 052 | <b>Stewie</b>                |
| 043 | <b>Colibrì</b>            | 053 | <b>Tress</b>                 |
| 044 | <b>Giga-Lite</b>          | 054 | <b>Tress Stilo</b>           |
| 045 | <b>Gregg</b>              | 055 | <b>Tuareg</b>                |
| 046 | <b>Havana</b>             | 056 | <b>Twice</b>                 |
| 047 | <b>Lightwing</b>          |     | <b>as Twiggy</b>             |
| 048 | <b>Lumiere <i>xxl</i></b> | 057 | <b>Twiggy</b>                |
| 049 | <b>Magneto</b>            | 058 | <b>Twiggy <i>lettura</i></b> |

## Aplomb

Lucidi e Pevere, 2013



	energy cl.	colours	code	vat excluded
<i>Aplomb terra</i>	A <sup>+</sup> , A, C	bianco	195003 10	643,00
		grigio	195003 25	
		marrone	195003 52	
<b>Spare parts:</b>				
<i>Dimmer</i>			LTD RONDO T/I	42,00

Concrete and coated metal

Halo or LED retrofit  
1x150W R7s  
Dimmer included minimum  
Halo bulb output 40W,  
with LED retrofit bulbs use  
dimmer only at full power





 IP 20

Colours: bianco,  
grigio cemento, marrone

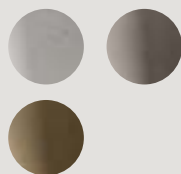

Weight:  
net kg 8,50

Halo, LED retrofit  
light bulbs not included  
→ specifications p. 182

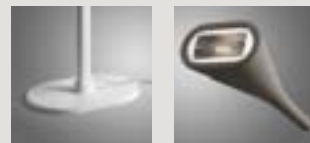
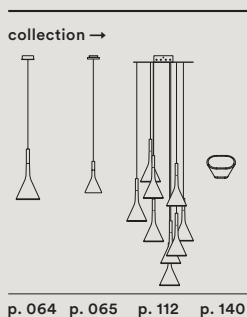
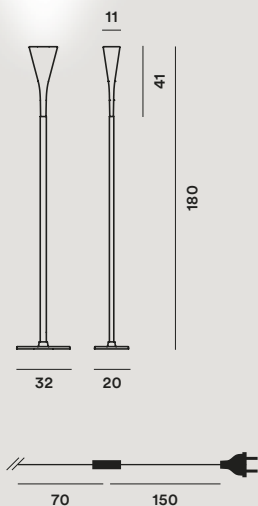

# Birdie

Ludovica + Roberto  
Palomba, 2011



Polycarbonate, coated steel  
and metal

*Birdie lettura on/off*  
LED retrofit or Fluo  
1x25W E27  
Halo 1x150W E27

*Birdie lettura with integrated  
touch dimmer*  
Halo or dimmable LED  
retrofit 1x150W E27 minimum  
Halo bulb output 40W

IP 20

	energy cl.	colours	code	vat excluded
<i>Birdie lettura on/off</i>	A+, A, B, C	bianco	221004S 10	311,00
		grigio	221004S 25	
		arancio	221004S 53	
		amaranto	221004S 65	
<i>Birdie lettura with touch dimmer</i>	A+, A, C	bianco	221004 10	370,00
		grigio	221004 25	
		arancio	221004 53	
		amaranto	221004 65	
<b>Spare parts:</b>				
<i>Lampshade Birdie</i>		bianco	221S00 10	66,00
		grigio	221S00 25	
		arancio	221S00 53	
		amaranto	221S00 65	

Colours: bianco, grigio,  
arancio, amaranto

Weight:  
net kg 4,30

Halo, Fluo, LED retrofit  
light bulbs not included  
→ specifications p. 182



Special colours  
on request

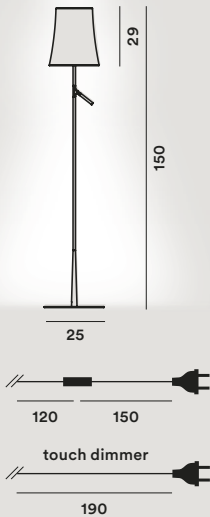

collection →

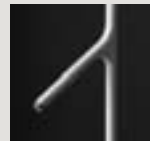
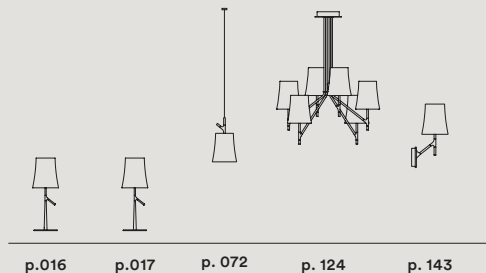

## Caboche

Patricia Urquiola  
con Eliana Gerotto, 2005



Polymethylmethacrylate,  
blown glass and white  
lacquered metal

**Caboche grande**  
Halo or dimmable LED  
retrofit 1x230W R7s  
Dimmer included minimum  
Halo bulb output 40W,  
with LED retrofit bulbs use  
dimmer only at full power

**Caboche media**  
Halo or dimmable LED  
retrofit 1x160W R7s  
Dimmer included minimum  
Halo bulb output 40W,  
with LED retrofit bulbs use  
dimmer only at full power

☐ ▽ CE IP 20

	energy cl.	colours	code	vat excluded
<b>Caboche grande</b>	A <sup>+</sup> , A, C	trasparente	138013 16	1.672,00
		giallo oro	138013 52	
<b>Caboche media</b>	A <sup>+</sup> , A, C	trasparente	138003 16	1.078,00
		giallo oro	138003 52	
<b>Spare parts:</b>				
<b>Set sphere Caboche grande</b>		trasparente	138S001 16	599,00
		giallo oro	138S001 52	
<b>Kit 20 prongs 4 sphere Caboche grande</b>			138KIT 20G4	37,00
<b>Kit 20 prongs 5 sphere Caboche grande</b>			138KIT 20G5	37,00
<b>Kit 3+3 prongs 4 + 5 sphere Caboche grande</b>			138KIT1-R2	20,00
<b>Set sphere Caboche media</b>		trasparente	138S00 16	322,00
		giallo oro	138S00 52	
<b>Kit 15 prongs 3 sphere Caboche media</b>			138KIT 15M3	29,00
<b>Kit 15 prongs 4 sphere Caboche media</b>			138KIT 15M4	29,00
<b>Kit 3+3 prongs 3 + 4 sphere Caboche media</b>			138KIT-R2	21,00
<b>Glass Caboche grande</b>			138V011/I	120,00
<b>Glass Caboche media</b>			138V01R1/I	80,00
<b>Halogen protection glass</b>			PIREX138/2S4I	20,00
<b>Halo. protection disk Caboche grande</b>			138V021/I	49,00
<b>Halo. protection disk Caboche media</b>			138V02/I	37,00
<b>Dimmer</b>			LTD RONDO T/I	42,00

Colours: trasparente,  
giallo oro

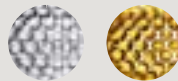

Special colours  
on request

Weight:  
**Caboche grande**  
net kg 23,90

**Caboche media**  
net kg 11,80

Halo, LED retrofit  
light bulbs not included  
→ specifications p. 182

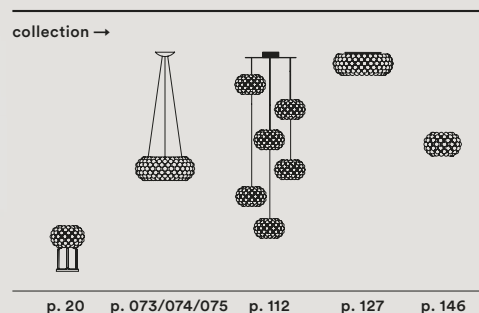
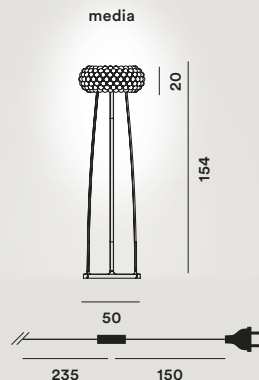
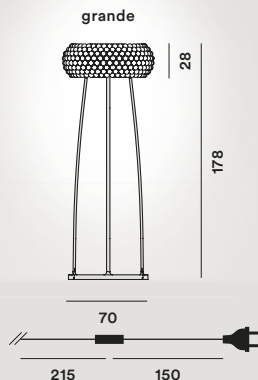



**Colibri**

Odoardo Fioravanti, 2011



Polycarbonate, coated  
aluminium and metal

dimnable LED retrofit or  
Halo 1x75W GU10 PAR  
Dimmer included  
minimum Halo bulb output  
40W

Adjustable lampshade on the  
vertical and horizontal axis

☐ ▽ CE IP 20

	energy cl.	colours	code	vat excluded
<i>Colibri</i>	A <sup>+</sup> , A, C	bianco	222004 10	452,00
<b>Spare parts:</b>				
<i>Dimmer</i>			LTD RT81 T/I	33,00

Colours: bianco



Weight:  
net kg 5,10

Halo, LED retrofit  
light bulbs not included  
→ specifications p. 182

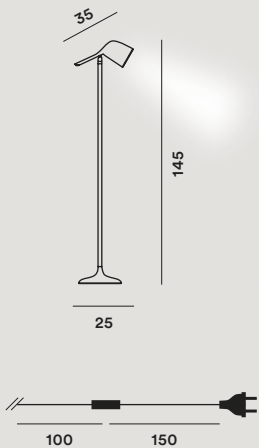

## Giga-Lite

Marc Sadler, 2004



Fiberglass fabric, carbonium thread and stainless steel

Extendable

Halo or dimmable LED retrofit 3x100W E27  
Dimmer included minimum total Halo bulb output 60W

☐ ▽ CE IP 20

	energy cl.	colours	code	vat excluded
<i>Giga-Lite</i>	A <sup>+</sup> , A, C	nero	139013 20	916,00
<b>Spare parts:</b>				
<i>Lampshade Giga-Lite</i>		nero	139S001 20	371,00
<i>Dimmer</i>			LTD RONDO T/I	42,00

Colours: nero



Weight:  
net kg 9,80

Halo, LED retrofit light bulbs not included  
→ specifications p. 182

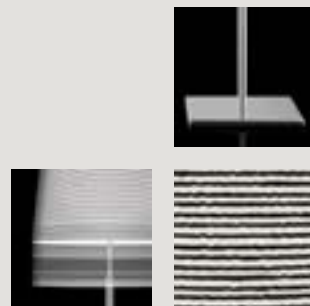
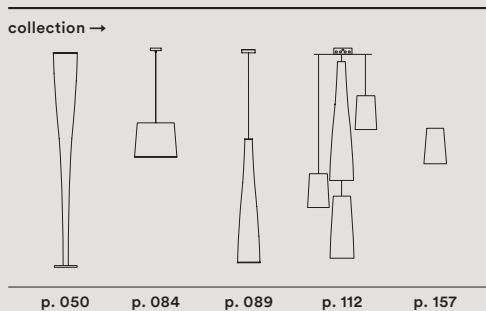

## Gregg

Ludovica + Roberto  
Palomba, 2010



Blown acid-etched glass,  
lacquered polyurethane and  
metal

Halo or dimmable LED  
retrofit 1x205W E27  
Dimmer included minimum  
Halo bulb output 40W

☐ ▽ CE IP 20

	energy cl.	colours	code	vat excluded
<i>Gregg grande</i>	A <sup>+</sup> , A, C	bianco	168013A 10	817,00
<i>Gregg media</i>	A <sup>+</sup> , A, C	bianco	168003A 10	671,00
<b>Spare parts:</b>				
<i>Glass Gregg grande</i>		bianco	168S0031 10	318,00
<i>Dimmer</i>			LTD RONDO T/I	42,00
<i>Glass Gregg media</i>		bianco	168S00 10	172,00
<i>Dimmer</i>			LTD RONDO T/I	42,00

Colours: bianco



Weight:

*Gregg grande*  
net kg 14,70

*Gregg media*  
net kg 11,70

Halo, LED retrofit  
light bulbs not included  
→ specifications p. 182

grande

47



40

185

44

media

31



26

168

36



100

150

collection →

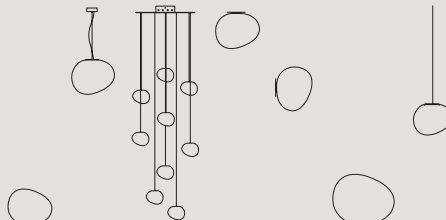

p. 023 p. 082 p. 112 p. 132 p. 154 p. 168 p. 171



**Havana**

Joseph Forakis, 1993



Injection moulded polyethylene and coated or chromed metal

*Havana on/off*  
LED retrofit or Fluo  
1x25W E27  
Halo 1x116W E27

*Havana with dimmer*  
Halo or dimmable LED retrofit 1x116W E27  
Dimmer included  
minimum Halo bulb output 60W



	energy cl.	colours	code	vat excluded
<i>Havana on/off</i>	A <sup>+</sup> , A, B, C	allum./bianco	040003 10	297,00
<i>Havana on/off</i>	A <sup>+</sup> , A, B, C	cromo/bianco	040003C 10	353,00
<i>Havana with dimmer</i>	A <sup>+</sup> , A, C	allum./bianco	040003 10 D	313,00
<i>Havana with dimmer</i>	A <sup>+</sup> , A, C	cromo/bianco	040003C 10 D	369,00

**Spare parts:**

<i>Set lampshades Havana</i>	bianco	040S00 10	79,00
<i>Dimmer</i>		LTD 5000TR/I	39,00

Lampshade:  
bianco



Frame:  
alluminio, cromo



Special colours  
on request

Weight:  
net kg 3,30

Halo, Fluo, LED retrofit  
light bulbs not included  
→ specifications p. 182

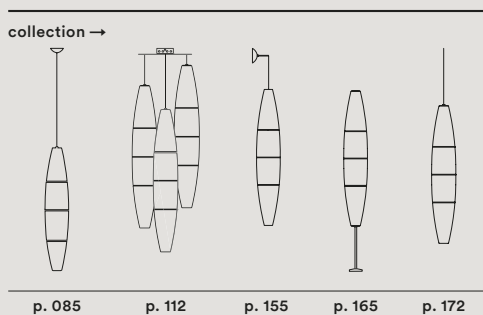
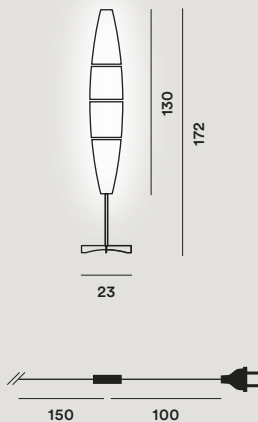

047

## Lightwing

Jean Marie Massaud, 2013

LED



	energy cl.	colours	code	vat excluded
<i>Lightwing</i>	A <sup>+</sup>	bianco	249003 10	1.264,00
		nero	249003 20	

Varnished aluminum and zinc alloy

Colours: bianco, nero

Weight:  
net kg 11,00

LED included  
Mid-power 34W 3000°K  
3157 lm CRI > 90 92,9 lm/W



Special colours  
on request

Dimmer included

Adjustable lampshade

⊕ CE ▽ IP 20

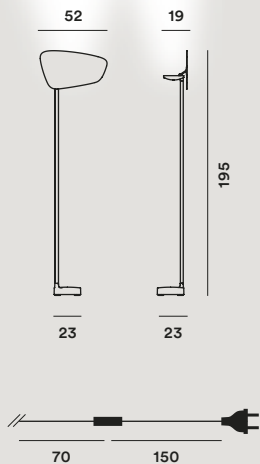

## Lumiere xxl

Rodolfo Dordoni, 2015



	energy cl.	colours	code	vat excluded
<i>Lumiere xxl</i>	A <sup>+</sup> , A, C	alluminio/bianco	191004A 11	1.000,00
		alluminio/grigio	191004A 24	
		alluminio/marrone	191004A 55	
		cromo nero/bianco	191004C 11	
		cromo nero/grigio	191004C 24	
		cr. nero/marrone	191004C 55	

### Spare parts:

<i>Glass Lumiere xxl</i>	bianco	191S001 11	335,00
	grigio	191S001 24	
	marrone	191S001 55	

Blown glass and lacquered aluminium

### Lumiere xxl

Halo or LED retrofit

4x33W G9

Dimmer included

minimum Halo bulb output

40W, with LED retrofit bulbs

use dimmer only at full

power

Glass colours:  
bianco, grigio freddo,  
marrone freddo



Frame colours:  
alluminio, cromo nero



Special colours  
on request

Weight:  
net kg 16,5

Halo, LED retrofit  
light bulbs not included  
→ specifications p. 182

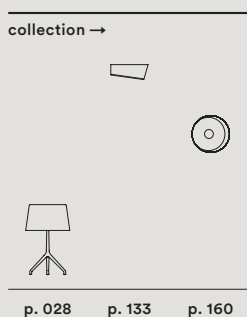
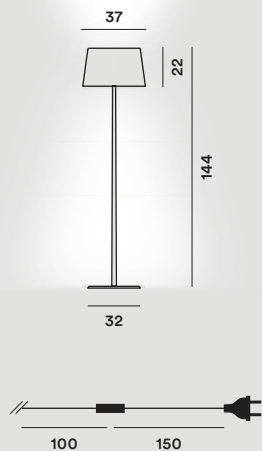

**Magneto**

Giuglio Iacchetti, 2011

**LED**

	energy cl.	colours	code	vat excluded
<b>Magneto</b>	A+	bianco	202004R2 10	387,00
		nero	202004R2 20	

Coated steel, ABS and super magnet made of "rare earth"

LED included  
Power LED 5W 2700° K  
475 lm CRI>80 95 lm/W

□ ▽ CE IP 20

Colours: bianco, nero



Special colours  
on request

Weight:  
net kg 2,80

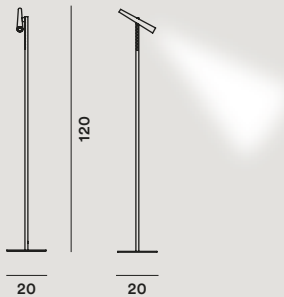

collection →



p. 029



**Mite**

Marc Sadler, 2000



	energy cl.	colours	code	vat excluded
<i>Mite halogen</i>	A <sup>+</sup> , A, C	giallo	111003R2 55	805,00
		nero	111003R2 20	
<i>Mite LED</i>	A	giallo	111003L 55	1.118,00
		nero	111003L 20	
<b>Spare parts:</b>				
<i>Lampshade Mite</i>		giallo	111S00 55	427,00
		nero	111S00 20	
<i>Dimmer halogen version</i>			LTD RONDO T/I	42,00

Fiber glass fabric with Kevlar or carbonium thread, nickel-plated metal, steel and alluminium (LED)  
Kevlar® is a Dupont registered trademark

Colours: giallo, nero



Weight:  
*Mite halogen*  
net kg 7,70

Halo, LED retrofit  
light bulbs not included  
→ specifications p. 182

*Mite LED*  
net kg 7,70



Compasso  
D'Oro 2001

*Mite halogen*

Halo or dimmable LED  
retrofit 1x150W E27  
Dimmer included minimum  
Halo bulb output 60W

*Mite LED*

LED included  
32W COB 3000°K 2500 lm  
CRI>90 78,1 lm/W  
Dimmer included

□ ▽ CE IP 20

Tecnico — 2017

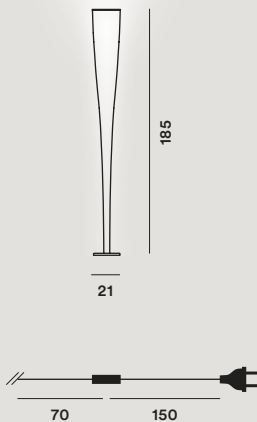

collection →

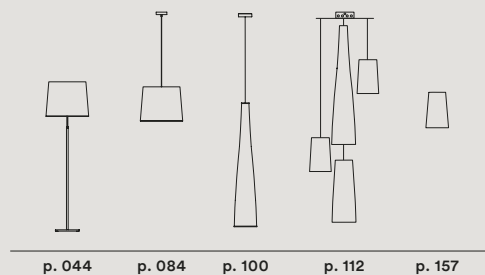

p. 044 p. 084 p. 100 p. 112 p. 157





## Orbital

Ferruccio Laviani, 1992



Silkscreen-printed glass and lacquered metal

LED retrofit or Halo  
5x30W E14

⊕ CE V IP 20

	energy cl.	colours	code	vat excluded
<i>Orbital</i>	A <sup>+</sup> , A, C	bianco colorato	036003 10 036003	866,00
<b>Spare parts:</b>				
<i>Glass set Orbital</i>		bianco colorato	036S01 10 036S01	220,00
<i>Glass Orbital 1</i>		rosso	043S00/1 10 043S00/1 63	50,00
<i>Glass Orbital 2</i>		blu	043S00/2 10 043S00/2 33	50,00
<i>Glass Orbital 3</i>			043S00/3 10	50,00
<i>Glass Orbital 4</i>			043S00/4 10	50,00
<i>Glass Orbital 5</i>			043S00/4 40 043S00/5 10 043S00/5 52	50,00

Colours: bianco, colorato Weight:  
net kg 10,10



Special colours  
on request

Halo, LED retrofit  
light bulbs not included  
→ specifications p. 182

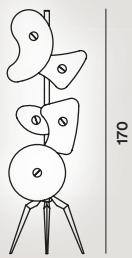

53

collection →



150

p. 144



## Stewie

Luca Nichetto, 2012



	energy cl.	colours	code	vat excluded
Stewie	A <sup>+</sup> , A	avorio/rosso	237003 63	767,00
		avorio/avorio*	237003 50	

\* limited stock available

Fabric coated polyethylene foam and lacquered metal

Fluo 1x40W 2GX13

⊕ ⚡ CE IP 20

Colours: avorio/rosso,



avorio/avorio\*

limited stock available



Weight:  
net kg 4,50

Fluo light bulbs not included  
→ specifications p. 182

Tecnico — 2017

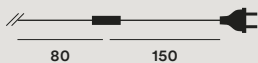
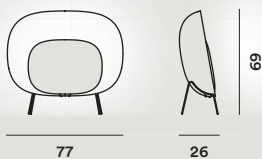

**Tress**

Marc Sadler, 2008



Compound material on lacquered fibre base, coated metal and aluminium

**Tress grande**

Halo or LED retrofit  
1x300W R7s  
+ LED retrofit or Halo  
1x100W E27 PAR  
Dimmer included  
Double switch minimum Halo  
bulb output 40W, with LED retrofit  
bulbs use dimmer only at full power

**Tress grande LED**

LED included  
56W (37,7 COB + 6,3 Mid-power + 13 COB) 2700° K  
3721 lm CRI>90 66 lm/W  
Dimmer included  
Double switch

IP 20

**Tress media**

dimnable LED retrofit or  
Halo 1x100W E27 PAR  
Dimmer included  
minimum Halo bulb output 40W

IP 20

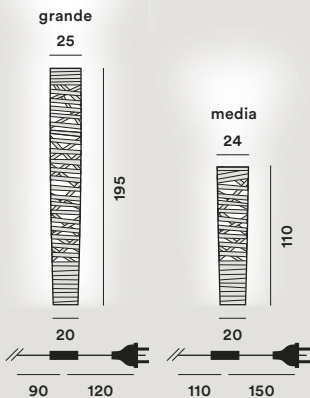

	energy cl.	colours	code	vat excluded
<b>Tress grande</b>	A <sup>+</sup> , A, C	bianco	182003 10	1.227,00
		nero	182003 20	
		cremisi	182003 67	
		greige	182003 25	
		indaco	182003 87	
<b>Tress grande LED</b>	A	bianco	182003L 10	1.726,00
		nero	182003L 20	
		cremisi	182003L 67	
		greige	182003L 25	
		indaco	182003L 87	
<b>Tress media</b>	A <sup>+</sup> , A, C	bianco	182004 10	660,00
		nero	182004 20	
		cremisi	182004 67	
		greige	182004 25	
		indaco	182004 87	

**Spare parts:**

<b>Lampshade Tress media</b>	bianco	182S02 10	492,00
	nero	182S02 20	
	cremisi	182S02 67	
	greige	182S02 25	
	indaco	182S02 87	

<b>Dimmer Tress grande halogen</b>	LTD RONDO4F/I	41,00
<b>Dimmer Tress media</b>	LTD RONDO T/I	42,00
<b>Halogen protection glass Tress grande</b>	PIREX138/2S4I	20,00

Colours: bianco, nero, cremisi, greige, indaco

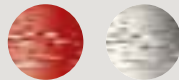
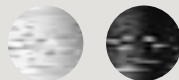

Special colours on request

Weight:  
**Tress grande**  
net kg 8,50

**Tress media**  
net kg 3,90

**Tress grande LED**  
net kg 11,00

Halo, LED retrofit  
light bulbs not included  
→ specifications p. 182

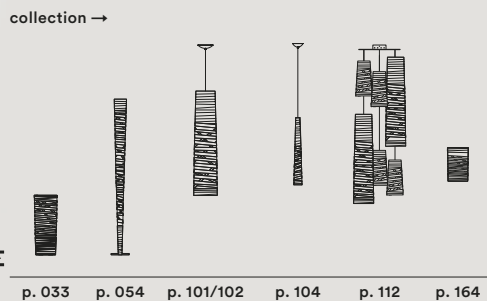

**Tress Stilo**

Marc Sadler, 2011



	energy cl.	colours	code	vat excluded
<i>Tress Stilo</i>	A <sup>+</sup> , A, C	bianco	182043 10	772,00
		nero	182043 20	

**Spare parts:**

<i>Lampshade Tress Stilo</i>	bianco	182S143 10	462,00
	nero	182S143 20	
<i>Dimmer</i>		LTD RT81 T/I	33,00

Coated fibreglass-based composite material, lacquered metal and steel

dimmable LED retrofit or Halo 1x100W E27 PAR  
Dimmer included minimum Halo bulb output 40W

☐ ▽ CE IP 20

Colours: bianco, nero



Special colours on request

Weight: net kg 4,20

Halo, LED retrofit light bulbs not included → specifications p. 182

Tecnico — 2017

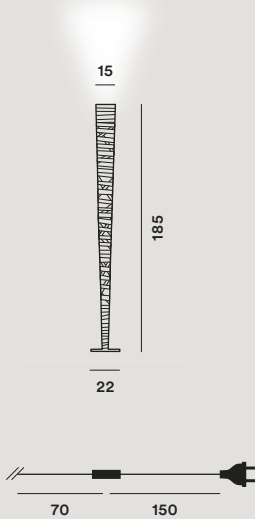

collection →

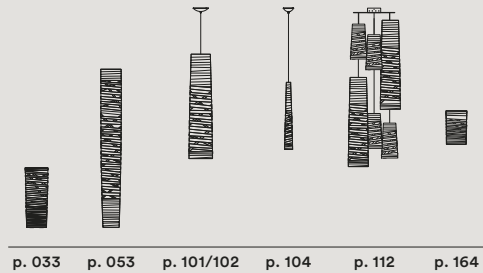

**Tuareg**

Ferruccio Laviani, 2013

LED



	energy cl.	colours	code	vat excluded
<i>Tuareg</i>	A	arancio	255003 53	2.672,00
		cromo nero	255003 78	3.008,00

Varnished aluminium and polycarbonate

LED included  
54W (3x18 Mid-power)  
3000°K 4050 lm  
CRI > 90 75 lm/W

3 separate switches and integrated touch dimmer  
orientable lights

□ ▽ CE ◀ IP 20

Colours: arancio, cromo nero

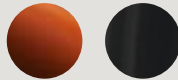

Special colours on request

Weight:  
net kg 9,20

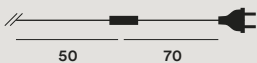
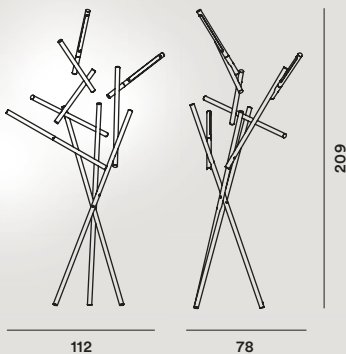

**Twice as Twiggy**

Marc Sadler, 2015



	energy cl.	colours	code	vat excluded
<i>Twice as Twiggy</i>	A+	bianco	275013 10	4.954,00
		nero	275013 20	
		greige	275013 25	
		cremisi	275013 67	
		indaco	275013 87	

**Spare parts:**

<i>Lampshade Twice as Twiggy</i>	bianco	275S001 10	1.918,00
	nero	275S001 20	
	greige	275S001 25	
	cremisi	275S001 67	
	indaco	275S001 87	

Coated fibreglass-based composite material, PMMA, polycarbonate, coated metal and aluminium.

LED included  
81W (54+27 Mid-power)  
3000° K 8517 lm  
CRI>90 106 lm/W  
Dimmer included

☐ CE ⚡ IP 20

Colours: bianco, nero, cremisi, greige, indaco

Weight:  
net kg 57,60

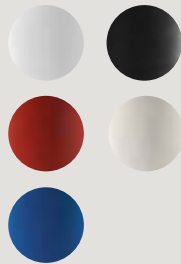

Special colours on request

Tecnico — 2017

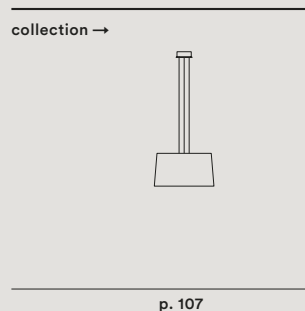
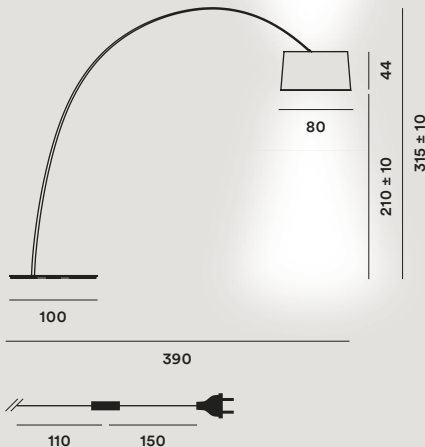

## Twiggy

Marc Sadler, 2006



Coated fibreglass-based composite material, PMMA, polycarbonate, coated metal and aluminium (LED)

### Twiggy

Halo or dimmable LED  
retrofit 3x150W E27  
Dimmer included minimum  
Halo bulb output 60W

### Twiggy LED

LED included  
33W (25+8 Mid-power) 3000° K  
3448 lm CRI>90 104,5 lm/W  
Dimmer included

IP 20

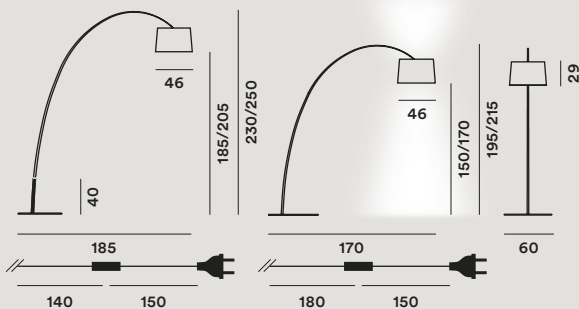
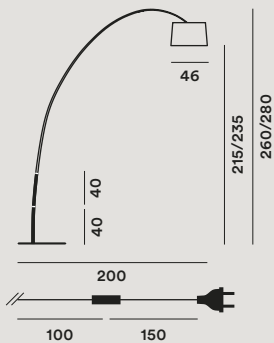

	energy cl.	colours	code	vat excluded
<i>Twiggy</i>	A <sup>+</sup> , A, C	bianco	159003 10	1.084,00
		nero	159003 20	
		greige	159003 25	
		cremisi	159003 67	
		indaco	159003 87	
<i>Twiggy LED</i>	A <sup>+</sup>	bianco	159003L 10	1.517,00
		nero	159003L 20	
		greige	159003L 25	
		cremisi	159003L 67	
		indaco	159003L 87	

### Accessories

<i>Additional stem set Twiggy (40 cm +40 cm)</i>	bianco	159S031 10	168,00
	nero	159S031 20	
	greige	159S031 25	
	cremisi	159S031 67	
	indaco	159S031 87	

### Spare parts:

<i>Lampshade Twiggy</i>	bianco	159S10 10	464,00
	nero	159S10 20	
	greige	159S10 25	
	cremisi	159S10 67	
	indaco	159S10 87	

<i>Dimmer for halogen version</i>	LTD RONDO T/I	42,00
<i>Lower diffusor disk</i>	159R05	33,00

Colours: bianco, nero, cremisi, greige, indaco

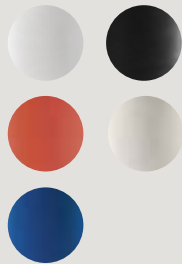

Special colours  
on request

Weight:  
*Twiggy*  
net kg 16,60

*Twiggy LED*  
net kg 17,10

Halo LED retrofit  
light bulbs not included  
→ specifications p. 182

collection →

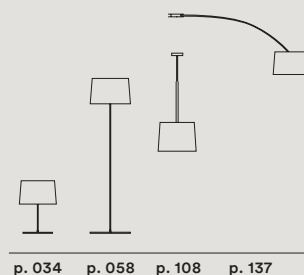

## Twiggy Lettura

Marc Sadler, 2008



Coated fibreglass-based composite material, PMMA, polycarbonate and coated metal

Halo or dimmable LED retrofit 3x100W E27  
Dimmer included minimum total Halo bulb output 60W

☐ ▽ CE IP 20

	energy cl.	colours	code	vat excluded
<i>Twiggy lettura</i>	A <sup>+</sup> , A, C	bianco	159004 10	903,00
		nero	159004 20	
<b>Spare parts:</b>				
<i>Lampshade Twiggy</i>		bianco	159S10 10	464,00
		nero	159S10 20	
<i>Dimmer</i>			LTD RONDO T/I	42,00

Colours: bianco, nero



Special colours on request

Weight:  
net kg 11,30

Halo, LED retrofit light bulbs not included  
→ specifications p. 182

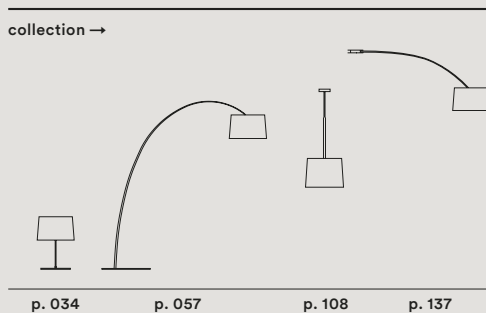
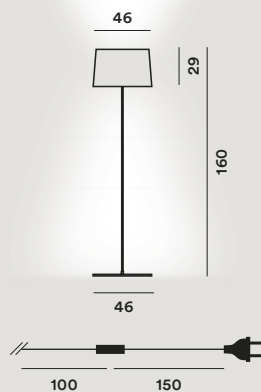







Sospensione, *Suspension*

- |     |                    |     |                        |
|-----|--------------------|-----|------------------------|
| 063 | <b>Allegro</b>     | 090 | <b>New Buds</b>        |
| 062 | <b>Allegretto</b>  | 091 | <b>O-Space</b>         |
| 064 | <b>Aplomb</b>      | 092 | <b>Planet</b>          |
| 067 | <b>Behive</b>      | 093 | <b>Plass</b>           |
| 068 | <b>Big Bang</b>    | 096 | <b>Rituals</b>         |
| 72  | <b>Birdie</b>      | 095 | <b>Spokes</b>          |
| 070 | <b>Buds</b>        | 098 | <b>Supernova</b>       |
| 073 | <b>Caboche</b>     | 099 | <b>Tartan</b>          |
| 076 | <b>Caiigo</b>      | 100 | <b>Tite</b>            |
| 077 | <b>Chouchin</b>    | 101 | <b>Tress</b>           |
| 084 | <b>Giga-Lite</b>   | 104 | <b>Tress Stilo</b>     |
| 082 | <b>Gregg</b>       | 105 | <b>Troag</b>           |
| 085 | <b>Havana</b>      | 106 | <b>Tropico</b>         |
| 086 | <b>Jamaica</b>     | 107 | <b>Twice as Twiggy</b> |
| 087 | <b>Le Soleil</b>   | 108 | <b>Twiggy</b>          |
| 088 | <b>Lightweight</b> | 109 | <b>Uto</b>             |
| 089 | <b>Maki</b>        | 110 | <b>Wave</b>            |

**Allegretto**

Atelier Oi, 2009



	energy cl.	colours	code	vat excluded
<i>Allegretto Ritmico</i>	A <sup>+</sup> , A, C	grafite	1690171 20	1.454,00
<i>Allegretto Ritmico h. 5 m</i>		grafite	1690171SP5 20	1.529,00
<i>Allegretto Vivace</i>	A <sup>+</sup> , A, C	rame	1690172 80	1.748,00
<i>Allegretto Vivace h. 5 m</i>		rame	1690172SP5 80	1.823,00
<i>Allegretto Assai</i>	A <sup>+</sup> , A, C	oro	1690173 71	2.010,00
<i>Allegretto Assai h. 5 m</i>		oro	1690173SP5 71	2.085,00

**Accessories:**

<i>Decentralization kit</i> for steel cables	KIT DEC B	28,00
for steel cables + canopy	KIT DEC F	49,00

Varnished aluminium and metal

LED retrofit  
2x12W E27 PAR 30  
Halo 2x100W E27 PAR 30



Colours: Assai oro,  
Vivace rame,  
Ritmico grafite



Special colours  
on request

Weight:  
*Allegretto Ritmico*  
net kg 5,10

*Allegretto Vivace*  
net kg 9,10

*Allegretto Assai*  
net kg 11,30

Halo, LED retrofit light  
bulbs not included  
→ specifications p. 182

Decentralization  
→ specifications p. 118

Ritmico

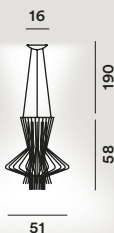

Vivace

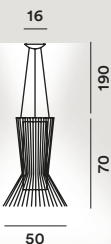

Assai

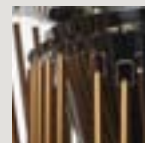

**Allegro**

Atelier Oi, 2007

LED



Varnished aluminium and metal

*Allegro LED included*  
51W (40 COB + 11 Multichip)  
3000°K 4266 lm  
CRI>90 84 lm/W  
Dimmable  
Possible configurations:  
On-Off/Push/DALI

*Allegro*  
LED retrofit or  
Halo 1x230W R7s +  
LED retrofit or  
Halo 1x100W E27 PAR 30

Double switch



	energy cl.	colours	code	vat excluded
<i>Allegro Ritmico LED</i>	A <sup>+</sup>	grafite	1690071L 20	2.891,00
<i>Allegro Vivace LED</i>		rame	1690072L 80	3.731,00
<i>Allegro Assai LED</i>		oro	1690073L 71	5.462,00
<i>Allegro Ritmico</i>	A <sup>+</sup> , A, C	grafite	1690071 20	2.555,00
<i>Allegro Vivace</i>		rame	1690072 80	3.395,00
<i>Allegro Assai</i>		oro	1690073 71	5.126,00

**Spare parts:**

<i>Halogen protection glass</i>	PIREX138/4/1	27,00
---------------------------------	--------------	-------

**Accessories:**

<i>Decentralization kit</i> for steel cables	KIT DEC B	28,00
for steel cables + canopy	KIT DEC F	49,00

Colours: Assai oro,  
Vivace rame,  
Ritmico grafite

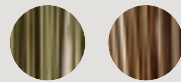

Special colours  
on request

Weight:  
*Allegro Ritmico*  
net kg 15,00

*Allegro Vivace*  
net kg 19,30

*Allegro Assai*  
net kg 36,00

*Allegro Ritmico LED*  
net kg 13,80

*Allegro Vivace LED*  
net kg 18,10

*Allegro Assai LED*  
net kg 34,80

Halo, LED retrofit  
light bulbs not included  
→ specifications p. 182

Decentralization  
→ specifications p. 118

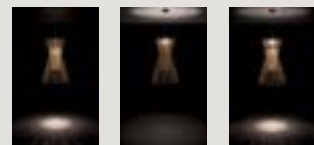
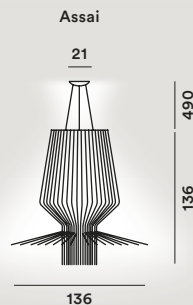
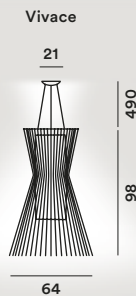
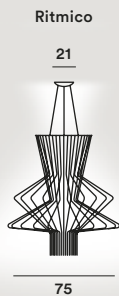

## Aplomb

Lucidi e Pevere, 2010



Concrete and aluminium

### Aplomb G9

Halo or LED retrofit 1x60W



### Aplomb GU10

LED retrofit 1x8W PAR 16



	energy cl.	colours	code	vat excluded
<i>Aplomb G9</i>	A <sup>+</sup> , A, C	bianco	195007 10	294,00
		grigio	195007 25	
		marrone	195007 52	
<i>Aplomb G9 h. 5 m</i>		bianco	195007SP5 10	315,00
		grigio	195007SP5 25	
		marrone	195007SP5 52	
<i>Aplomb GU10</i>	A <sup>+</sup> , A	bianco	195007L 10	294,00
		grigio	195007L 25	
		marrone	195007L 52	
<i>Aplomb GU10 h. 5 m</i>		bianco	195007LSP5 10	315,00
		grigio	195007LSP5 25	
		marrone	195007LSP5 52	

### Version without canopy with multiple canopy holder

<i>Aplomb G9</i>	A <sup>+</sup> , A, C	bianco	195007SR 10	285,00
		grigio	195007SR 25	
		marrone	195007SR 52	
<i>Aplomb G9 h. 5 m</i>		bianco	195007SR5 10	306,00
		grigio	195007SR5 25	
		marrone	195007SR5 52	
<i>Aplomb GU10</i>	A <sup>+</sup> , A	bianco	195007LSR 10	285,00
		grigio	195007LSR 25	
		marrone	195007LSR 52	
<i>Aplomb GU10 h. 5 m</i>		bianco	195007LSR5 10	306,00
		grigio	195007LSR5 25	
		marrone	195007LSR5 52	

### Accessories:

<i>Decentralization kit</i> for power cable	KIT DEC C	33,00
canopy for electrical dec.	KIT DEC M	86,00

Colours: bianco, grigio  
cemento, marrone



Weight:  
net kg 1,90

Halo, LED retrofit light  
bulbs not included  
→ specifications p. 182

Multiple canopy  
→ specifications p. 112

Decentralization  
→ specifications p. 118

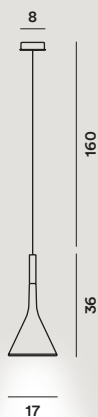

collection →

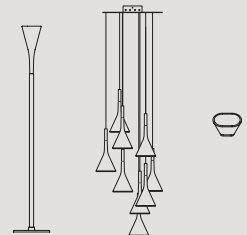

p. 040

p. 112

p. 140

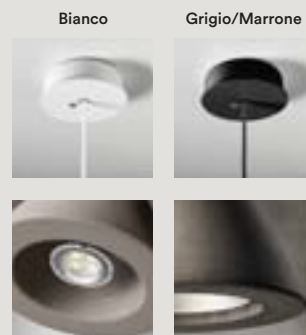

**Aplomb Large**

Lucidi e Pevere, 2016

LED



Concrete, aluminium and polycarbonate

LED Included  
11,7W Multichip mid power  
2700° K 1279 lm  
CRI>90 109 lm/W  
Dimmable LED version  
Possible configurations:  
On-Off/Push/DALI

⊕ CE IP 20

	energy cl.	colours	code	vat excluded
<i>Aplomb large</i>	A <sup>+</sup>	bianco	195017 10	500,00
		grigio	195017 25	
		marrone	195017 52	
<i>Aplomb large h. 5 m</i>	A <sup>+</sup>	bianco	195017/5 10	513,00
		grigio	195017/5 25	
		marrone	195017/5 52	
<i>Aplomb large dimmable</i>	A <sup>+</sup>	bianco	195017D 10	546,00
		grigio	195017D 25	
		marrone	195017D 52	
<i>Aplomb large dimmable h. 5 m</i>	A <sup>+</sup>	bianco	195017D/5 10	559,00
		grigio	195017D/5 25	
		marrone	195017D/5 52	

**Accessories:**

*Decentralization kit* for power cable KIT DEC C 33,00

Colours: *bianco, grigio cemento, marrone*

Weight:  
net kg 4,00

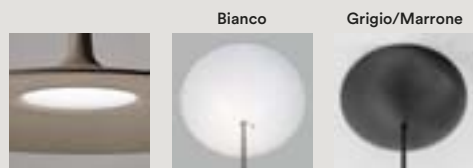
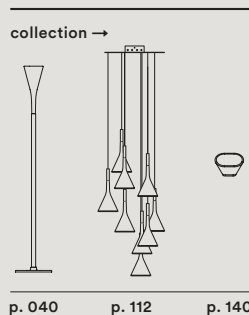
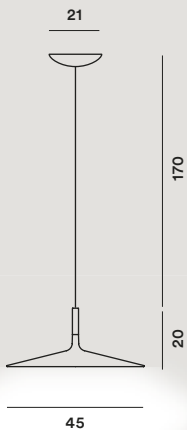

## Aplomb mini

Lucidi e Pevere, 2015

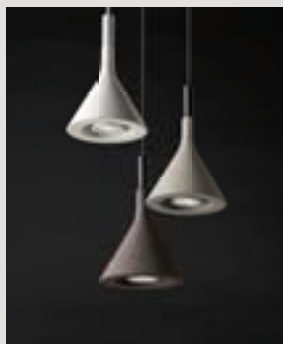

Concrete

LED retrofit GU10  
1x8W PAR 16



	energy cl.	colours	code	vat excluded
<i>Aplomb mini</i>	A+, A	bianco	195027 10	210,00
		grigio	195027 25	
		marrone	195027 52	
<i>Aplomb mini h. 5 m</i>	A+, A	bianco	195027/5 10	231,00
		grigio	195027/5 25	
		marrone	195027/5 52	
<b>Version without canopy with multiple canopy holder</b>				
<i>Aplomb mini</i>	A+, A	bianco	195027SR 10	201,00
		grigio	195027SR 25	
		marrone	195027SR 52	
<i>Aplomb mini h. 5 m</i>	A+, A	bianco	195027SR5 10	222,00
		grigio	195027SR5 25	
		marrone	195027SR5 52	

**Accessories:**

<i>Decentralization kit</i> for power cable	KIT DEC C	33,00
canopy for electrical dec.	KIT DEC M	86,00

Colours: bianco, grigio  
cemento, marrone

Weight:  
net kg 0,70



LED retrofit light bulbs  
not included  
→ specifications p. 182

Multiple canopy  
→ specifications p. 112

Decentralization  
→ specifications p. 118



p. 040

p. 112

p. 140

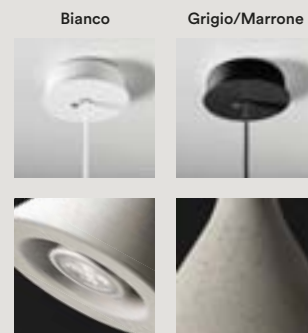



# 067 Sospensione, *Suspension*

## Behive

Werner Aisslinger, 2012



	energy cl.	colours	code	vat excluded	
<i>Behive</i>	A <sup>+</sup> , A, B, C	bianco	203007 10	437,00	
<i>Behive h. 5 m</i>		bianco	203007SP5 10	471,00	
<b>Spare parts:</b>					
<i>Lampshade Behive</i>		bianco	203S007 10	211,00	
<i>Protection glass</i>			203V02/1	49,00	
<b>Accessories:</b>					
<i>Decentralization kit</i> for steel cables			KIT DEC B	28,00	
			for steel cables + canopy	KIT DEC F	49,00
			canopy for electrical dec.	KIT DEC M	86,00

Batch-dyed ABS and polycarbonate

LED retrofit or Fluo 1x25W E27  
Halo 1x150W E27

⊕ ⚡ CE IP 20

Colours: bianco



Special colours on request

Weight: net kg 3,10

Halo, Fluo, LED retrofit light bulbs not included → specifications p. 182

Decentralization → specifications p. 118

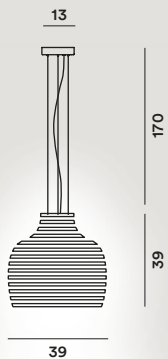

collection →



p. 015



**Big Bang**

Enrico Franzolini con  
Vicente Garcia Jimenez, 2005

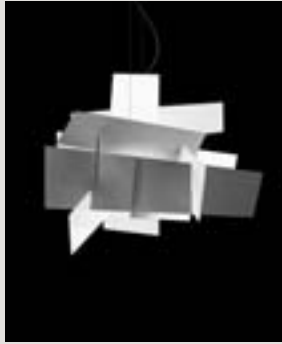

Methacrylate and coated aluminium

**Big Bang LED** Included  
37,7 W Mid power 3000° K  
3885 lm CRI>90 103 lm/W  
Dimmable LED version  
Possible configurations:  
On-Off/Push/DALI

**Big Bang**  
Halo or LED retrofit  
1x160W R7s

**Big Bang fluorescent**  
Fluo 1x26W GX24q-3



	energy cl.	colours	code	vat excluded
<b>Big Bang LED</b>	A <sup>+</sup>	bianco	151007L 10	1.082,00
		rosso	151007L 63	1.199,00
<b>Big Bang LED dimmable</b>	A <sup>+</sup>	bianco	151007LD 10	1.168,00
		rosso	151007LD 63	1.285,00
<b>Big Bang LED h. 5 m</b>		bianco	151007LSP5 10	1.129,00
		rosso	151007LSP5 63	1.246,00
<b>Big Bang LED h. 5 m dimmable</b>		bianco	151007LD5 10	1.215,00
		rosso	151007LD5 63	1.332,00
<b>Big Bang</b>	A <sup>+</sup> , A, C	bianco	151007 10	639,00
		rosso	151007 63	756,00
<b>Big Bang h. 5 m</b>		bianco	151007 10SP5	685,00
		rosso	151007 63SP5	802,00
<b>Big Bang fluorescent</b>	A <sup>+</sup> , A	bianco	151007F 10	665,00
		rosso	151007F 63	782,00

**Spare parts:**

<b>Set lampshades Big Bang</b>	bianco	151S00 10	259,00
	rosso	151S00 63	376,00
<b>Halogen protection glass</b>		PIREX180-50/I	25,00

**Accessories:**

<b>Decentralization kit</b> for steel cables		KIT DEC B	28,00
	for steel cables + canopy	KIT DEC F	49,00
	canopy for electrical dec.	KIT DEC M	86,00

Colours: bianco, rosso



Special colours on request

Weight:  
**Big Bang LED**  
net kg 7,40

**Big Bang**  
net kg 5,40

Halo, Fluo, LED retrofit light bulbs not included  
→ specifications p. 182

Decentralization  
→ specifications p. 118

Big Bang / Big Bang LED

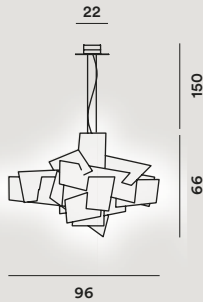

Big Bang Fluo

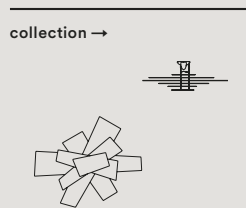
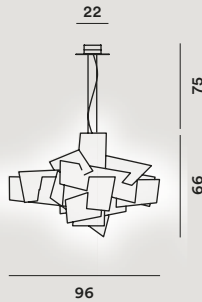

## Big Bang L - XL

Enrico Franzolini con  
Vicente Garcia Jimenez,  
2005-2016



Methacrylate and coated  
aluminium

### Big Bang L

LED Included  
58W Mid power 3000° K  
6084 lm CRI>90 105 lm/W  
Dimmable  
Possible configurations:  
On-Off/Push/DALI

### Big Bang XL

LED Included  
87W Mid power 3000° K  
9126 lm CRI>90 105 lm/W  
Dimmable  
Possible configurations:  
On-Off/Push/DALI

### Big Bang XL R7s

Halo or LED retrofit  
1x160W

⊕ CE IP 20

LED

	energy cl.	colours	code	vat excluded
<i>Big Bang L LED</i>	A <sup>+</sup>	bianco	151017 10	2.168,00
		rosso	151017 63	2.299,00
<i>Big Bang XL LED</i>	A <sup>+</sup>	bianco	1510072L 10	3.474,00
		rosso	1510072L 63	4.002,00
<i>Big Bang XL R7s</i>	A <sup>+</sup> , A, C	bianco *	1510072 10	3.474,00
		rosso *	1510072 63	4.002,00
<b>Ricambi</b>				
<i>Set diffusori Big Bang L</i>		bianco	151S001 10	903,00
		rosso	151S001 63	1.034,00
<i>Set diffusori Big Bang XL</i>		bianco	151S002 10	1.766,00
		rosso	151S002 63	2.294,00
<i>Vetro protezione alogena</i>			PIREX180-50/I	25,00
<b>Accessories:</b>				
<i>Decentralization kit</i> for steel cables			KIT DEC B	28,00
		for steel cables + canopy	KIT DEC F	49,00
		canopy for electrical dec.	KIT DEC M	86,00

\* limited stock available

Colours: bianco, rosso



Special colours  
on request

Weight:

*Big Bang L*  
net kg 21,00

*Big Bang XL*  
net kg 35,00

Halo, Fluo, LED retrofit  
light bulbs not included  
→ specifications p. 182

Decentralization  
→ specifications p. 118

Big Bang L

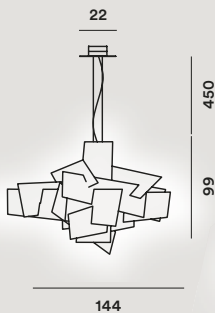

Big Bang XL

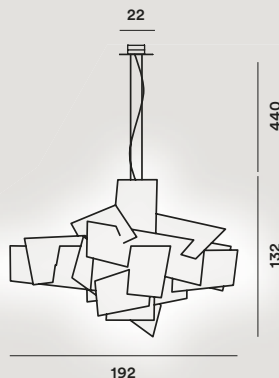

collection →

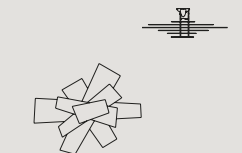

p. 142

p. 123



## 070 Sospensione, Suspension

### Buds

Rodolfo Dordoni, 2016



Blown glass

*Buds 1-2-3 E27*

LED retrofit / Fluo

max 1x23W E27

Ø 9-12 cm

White globe bulb  
recommended

Ø 12 cm for Buds 1-2

Ø 9 cm for Buds 3

*Buds 1-2-3 LED Included*

24W COB 2700° K

2676 lm CRI>90 111 lm/W

Dimmable version

Possible configurations:

On-Off/Push/DALI

On request on/off or  
dimmable

24W COB 3000° K

3385 lm CRI>80 141 lm/W

⊕ CE IP 20

	energy cl.	colours	code	vat excluded
<i>Buds 1</i>	A <sup>+</sup> , A, B	bianco caldo	278071 12	513,00
		marrone	278071 54	
<i>Buds 2</i>		bianco caldo	278072 12	546,00
		grigio	278072 24	
<i>Buds 3</i>		bianco caldo	278073 12	482,00
		verde	278073 40	
<i>Buds 1 LED</i>	A <sup>+</sup>	bianco caldo	278071L 12	630,00
		marrone	278071L 54	
<i>Buds 2 LED</i>		bianco caldo	278072L 12	663,00
		grigio	278072L 24	
<i>Buds 3 LED</i>		bianco caldo	278073L 12	599,00
		verde	278073L 40	
<i>Buds 1 LED dimmable</i>		bianco caldo	278071LD 12	684,00
		marrone	278071LD 54	
<i>Buds 2 LED dimmable</i>		bianco caldo	278072LD 12	717,00
		grigio	278072LD 24	
<i>Buds 3 LED dimmable</i>		bianco caldo	278073LD 12	653,00
		verde	278073LD 40	
<i>Buds 1 h. 5 m</i>	A <sup>+</sup> , A, B	bianco caldo	278071/5 12	542,00
		marrone	278071/5 54	
<i>Buds 2 h. 5 m</i>		bianco caldo	278072/5 12	575,00
		grigio	278072/5 24	
<i>Buds 3 h. 5 m</i>		bianco caldo	278073/5 12	511,00
		verde	278073/5 40	
<i>Buds 1 LED h. 5 m</i>	A <sup>+</sup>	bianco caldo	278071L/5 12	649,00
		marrone	278071L/5 54	
<i>Buds 2 LED h. 5 m</i>		bianco caldo	278072L/5 12	682,00
		grigio	278072L/5 24	
<i>Buds 3 LED h. 5 m</i>		bianco caldo	278073L/5 12	618,00
		verde	278073L/5 40	

Colours:

*Buds 1* bianco caldo,  
marrone.

*Buds 2* bianco caldo,  
grigio.

*Buds 3* bianco caldo,  
verde bambù



Weight:

*Buds 1*  
net kg 3,20

*Buds 2*  
net kg 4,20

*Buds 3*  
net kg 3,20

*Buds 1 LED*  
net kg 3,90

*Buds 2 LED*  
net kg 4,90

*Buds 3 LED*  
net kg 3,90

Fluo, LED retrofit light  
bulbs not included  
specifications p. 182

	energy cl.	colours	code	vat excluded
<b>Buds 1 LED dimmable</b>	A <sup>+</sup>	bianco caldo	278071LD/5 12	703,00
<b>h. 5 m</b>		marrone	278071LD/5 54	
<b>Buds 2 LED dimmable</b>		bianco caldo	278072LD/5 12	736,00
<b>h. 5 m</b>		grigio	278072LD/5 24	
<b>Buds 3 LED dimmable</b>		bianco caldo	278073LD/5 12	672,00
<b>h. 5 m</b>		verde	278073LD/5 40	
<b>Buds 1</b>	A <sup>+</sup> , A, B	bianco caldo	278071SR 12	503,00
		marrone	278071SR 54	
<b>Buds 2</b>		bianco caldo	278072SR 12	536,00
		grigio	278072SR 24	
<b>Buds 3</b>		bianco caldo	278073SR 12	472,00
		verde	278073SR 40	
<b>Buds 1 h. 5 m</b>		bianco caldo	278071SR5 12	532,00
		marrone	278071SR5 54	
<b>Buds 2 h. 5 m</b>		bianco caldo	278072SR5 12	565,00
		grigio	278072SR5 24	
<b>Buds 3 h. 5 m</b>		bianco caldo	278073SR5 12	501,00
		verde	278073SR5 40	

**Version without canopy with multiple canopy holder**

Buds 1



Buds 2

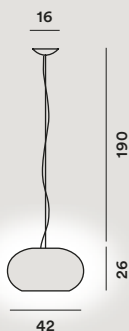

Buds 3

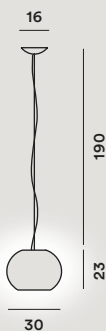

Buds 1 LED



Buds 2 LED



Buds 3 LED

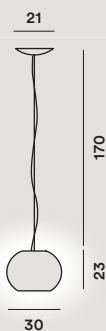

collection →



**Birdie**

Ludovica + Roberto  
Palomba, 2013



Metallized polycarbonate  
and metallized steel

*Birdie grande bianco*  
LED retrofit or Fluo 1x25W E27  
Halo 1x150W E27

*Birdie piccola bianco*  
LED retrofit or Fluo 1x20W E27  
Halo 1x70W E27

*Birdie grande Metal*  
LED retrofit or Fluo 1x25W E27

*Birdie piccola Metal*  
LED retrofit or Fluo 1x20W E27

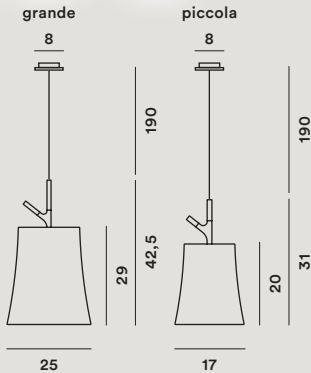
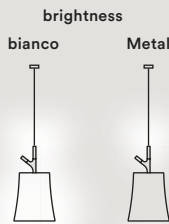

	energy cl.	colours	code	vat excluded
<i>Birdie grande</i>	A <sup>+</sup> , A, B, C	bianco	221017 10	193,00
<i>Birdie grande h. 5 m</i>		bianco	221017/5 10	218,00
<i>Birdie piccola</i>	A <sup>+</sup> , A, B, C	bianco	221027 10	164,00
<i>Birdie piccola h. 5 m</i>		bianco	221027/5 10	189,00
<i>Birdie grande Metal</i>	A <sup>+</sup> , A	rame	221017 57	305,00
		cromo	221017 78	
<i>Birdie grande Metal h. 5 m</i>		rame	221017/5 57	330,00
		cromo	221017/5 78	
<i>Birdie piccola Metal</i>	A <sup>+</sup> , A	rame	221027 57	231,00
		cromo	221027 78	
<i>Birdie piccola Metal h. 5 m</i>		rame	221027/5 57	256,00
		cromo	221027/5 78	

Version without canopy with multiple canopy holder

<i>Birdie grande</i>	A <sup>+</sup> , A, B, C	bianco	221017SR 10	176,00
<i>Birdie grande h. 5 m</i>		bianco	221017SR5 10	201,00
<i>Birdie piccola</i>	A <sup>+</sup> , A, B, C	bianco	221027SR 10	147,00
<i>Birdie piccola h. 5 m</i>		bianco	221027SR5 10	172,00
<i>Birdie grande Metal</i>	A <sup>+</sup> , A	rame	221017SR 57	288,00
		cromo	221017SR 78	
<i>Birdie grande Metal h. 5 m</i>		rame	221017SR5 57	313,00
		cromo	221017SR5 78	
<i>Birdie piccola Metal</i>	A <sup>+</sup> , A	rame	221027SR 57	214,00
		cromo	221027SR 78	
<i>Birdie piccola Metal h. 5 m</i>		rame	221027SR5 57	239,00
		cromo	221027SR5 78	

Accessories:

<i>Decentralization kit</i> for power cable	KIT DEC C	33,00
canopy for electrical dec.	KIT DEC M	86,00

Colours: bianco, cromo  
nero, rame

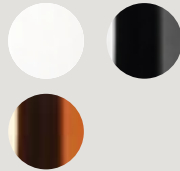

Weight:  
*Birdie grande*  
net kg 1,30

*Birdie piccola*  
net kg 1,00

Halo, Fluo, LED retrofit  
light bulbs not included  
→ specifications p. 182

Decentralization  
→ specifications p. 118

collection →

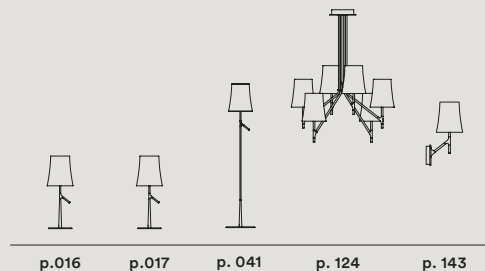

## Caboche grande

Patricia Urquiola  
con Eliana Gerotto, 2005



PMMA, blown glass,  
chromed metal and  
aluminium (LED)

*Caboche grande*  
LED Included  
46W (36 + 10 Mid-power)  
3000°K 4330 lm  
CRI>90 94,1 lm/W  
Dimmable version  
Possible configurations:  
On-Off/Push/DALI

*Caboche grande*  
LED retrofit or Halo  
1x230W R7s

⊕ ⊖ CE IP 20



	energy cl.	colours	code	vat excluded
<i>Caboche grande LED</i>	A <sup>+</sup>	trasparente	138017L 16	2.101,00
		giallo oro	138017L 52	
<i>Caboche grande LED</i> <i>h. 5 m</i>		trasparente	138017LSP5 16	2.210,00
		giallo oro	138017LSP5 52	
<i>Caboche grande LED</i> <i>h. 5 m dimmable</i>	A <sup>+</sup>	trasparente	138017LD 16	2.185,00
		giallo oro	138017LD 52	
<i>Caboche grande LED</i> <i>h. 5 m dimmable</i>		trasparente	138017LD5 16	2.294,00
		giallo oro	138017LD5 52	
<i>Caboche grande</i>	A <sup>+</sup> , A, C	trasparente	138017 16	1.479,00
		giallo oro	138017 52	
<i>Caboche grande h. 5 m</i>		trasparente	138017SP5 16	1.588,00
		giallo oro	138017SP5 52	

### Spare parts:

<i>Set spheres Caboche grande</i>	trasparente	138S001 16	599,00
	giallo oro	138S001 52	
<i>Kit 20 pron. 4 spheres Caboche</i>		138KIT 20G4	37,00
<i>Kit 20 pron. 5 spheres Caboche</i>		138KIT 20G5	37,00
<i>Kit 3+3 pron. 4+5 spheres Caboche</i>		138KIT1-R2	20,00
<i>Inner glass Caboche LED</i>		138V0118/I	118,00
<i>Inner glass Caboche halogen</i>		138V011/I	120,00
<i>Halogen protection glass</i>		PIREX138/2S4I	20,00
<i>Halogen protection disk Caboche</i>		138V021/I	49,00

### Accessories:

<i>Decentralization kit</i> for steel cables		KIT DEC B	28,00
	for steel cables + canopy	KIT DEC F	49,00
	canopy for electrical dec.	KIT DEC M	86,00

Colours: bianco, giallo oro Weight:  
*Caboche grande*  
LED  
net kg 17,00

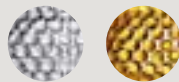

Special colours  
on request

Halo, LED retrofit  
light bulbs not included  
→ specifications p. 182

Decentralization  
→ specifications p. 118

*Caboche grande*  
net kg 19,60

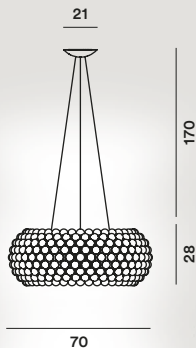

collection →

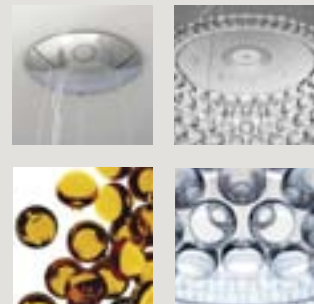
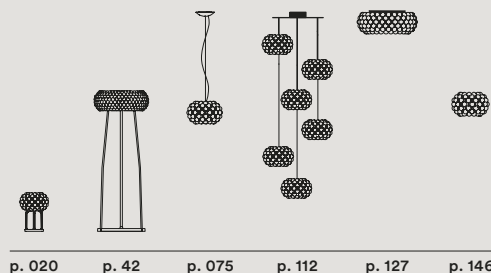

**Caboche media**

Patricia Urquiola  
con Eliana Gerotto, 2005



PMMA, blown glass,  
chromed metal and  
aluminium (LED)

*Caboche media*  
LED Included  
35W (28 + 7Mid power)  
3000°K 3665 lm  
CRI > 90 104,4 lm/W  
Dimmable version  
Possible configurations:  
On-Off/Push/DALI

*Caboche media*  
LED retrofit or Halo  
1x160W R7s



	energy cl.	colours	code	vat excluded
<i>Caboche media LED</i>	A <sup>+</sup>	trasparente	138007L 16	1.168,00
		giallo oro	138007L 52	
<i>Caboche media LED</i> <i>h. 5 m</i>		trasparente	138007LSP5 16	1.209,00
		giallo oro	138007LSP5 52	
<i>Caboche media LED</i> <i>dimmable</i>	A <sup>+</sup>	trasparente	138007LD 16	1.252,00
		giallo oro	138007LD 52	
<i>Caboche media LED</i> <i>dimmable h. 5 m</i>		trasparente	138007LD5 16	1.293,00
		giallo oro	138007LD5 52	
<i>Caboche media</i>	A <sup>+</sup> , A, C	trasparente	138007 16	829,00
		giallo oro	138007 52	
<i>Caboche media h. 5 m</i>		trasparente	138007 16SP5	893,00
		giallo oro	138007 52SP5	

**Spare parts:**

<i>Set spheres Caboche media</i>	trasparente	138S00 16	322,00
	giallo oro	138S00 52	
<i>Kit 15 pron. 3 spheres Caboche</i>		138KIT 15M3	29,00
<i>Kit 15 pron. 4 spheres Caboche</i>		138KIT 15M4	29,00
<i>Kit 3+3 pron. 3 + 4 spheres Caboche</i>		138KIT-R2	21,00
<i>Inner glass Caboche halogen</i>		138V01R1/I	80,00
<i>Inner glass Caboche LED</i>		138V018/I	91,00
<i>Halogen protection glass</i>		PIREX138/2S4I	20,00
<i>Disco protezione halogen</i>		138V02/I	37,00

**Accessories:**

<i>Decentralization kit</i> for steel cables	KIT DEC B	28,00
	for steel cables + canopy	

Colours: bianco, giallo oro

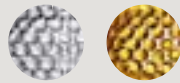

Special colours  
on request

Weight:

*Caboche media*  
LED  
net kg 10,20

*Caboche media*  
net kg 10,20

Halo, LED retrofit light bulbs  
not included

→ specifications p. 182

Decentralization

→ specifications p. 118

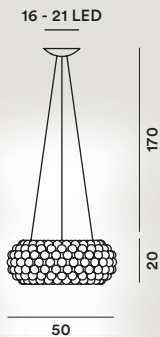

collection →

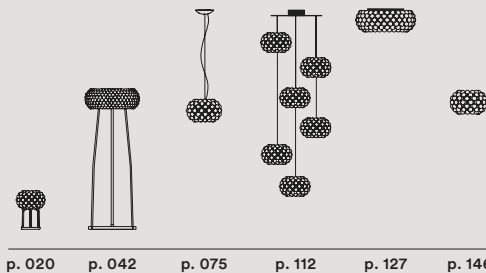



## Caboche piccola

Patricia Urquiola  
con Eliana Gerotto, 2005



PMMA, blown glass and  
chromed metal

LED retrofit or Halo  
1x60W G9

⊕ ⚡ CE IP 20

	energy cl.	colours	code	vat excluded
<i>Caboche piccola</i>	A <sup>+</sup> , A, C	trasparente	138027 16	403,00
		giallo oro	138027 52	
<i>Caboche piccola h. 5 m</i>		trasparente	138027SP5 16	454,00
		giallo oro	138027SP5 52	

### Version without canopy with multiple canopy holder

<i>Caboche piccola</i>	A <sup>+</sup> , A, C	trasparente	138027SR 16	383,00
		giallo oro	138027SR 52	
<i>Caboche piccola h. 5 m</i>		trasparente	138027SR5 16	434,00
		giallo oro	138027SR5 52	

### Spare parts:

<i>Set spheres Caboche piccola</i>	trasparente	138S002 16	160,00
	giallo oro	138S002 52	
<i>Kit 10 prongs 3 spheres Caboche</i>		138KIT 10P3	24,00
<i>Kit 10 prongs 4 spheres Caboche</i>		138KIT 10P4	24,00
<i>Kit 3+3 prongs 3 + 4 spheres Caboche</i>		138KIT2-R2	18,00
<i>Inner glass Caboche piccola</i>		138V012/1	42,00

### Accessories:

<i>Decentralization kit</i> for steel cables		KIT DEC B	28,00
	for steel cables + canopy	KIT DEC F	49,00
	canopy for electrical dec.	KIT DEC M	86,00

Colours: bianco, giallo oro Weight:  
net kg 4,80

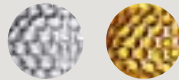

Special colours  
on request

Halo, LED retrofit light  
bulbs not included  
→ specifications p. 182

Multiple canopy  
→ specifications p. 112

Decentralization  
→ specifications p. 118

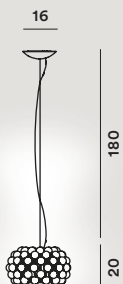

31

collection →

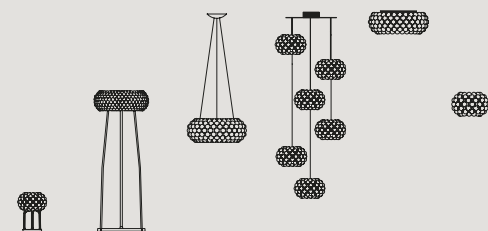

p. 020 p. 042 p. 073/074 p. 112 p. 127 p. 146



## 076 Sospensione, *Suspension*

### Caiigo

Marco Zito, 2016



Blown glass and aluminium

LED retrofit  
1x8W GU10 PAR 16

⊕ ⚡ CE IP 20

	energy cl.	colours	code	vat excluded
<i>Caiigo</i>	A+, A, C	bianco	266007 15	403,00
<i>Caiigo h. 5 m</i>		bianco	266007/5 15	433,00

#### Version without canopy with multiple canopy holder

<i>Caiigo</i>		bianco	266007SR 15	393,00
<i>Caiigo h. 5 m</i>		bianco	266007SR5 15	423,00

#### Ricambi:

<i>Lampshade Caiigo</i>		bianco	266S00 15	244,00
-------------------------	--	--------	-----------	--------

#### Accessories:

<i>Decentralization kit</i> for steel cables			KIT DEC B	28,00	
			for steel cables + canopy	KIT DEC F	49,00
			canopy for electrical dec.	KIT DEC M	86,00

Colours: bianco sfumato    Weight:  
net kg 2,00



LED retrofit light bulbs  
not included  
→ specifications p. 182

Multiple canopy  
→ specifications p. 112

Decentralization  
→ specifications p. 118

Tecnico — 2017

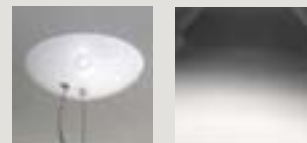
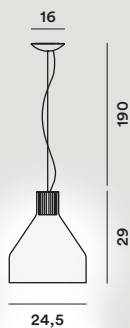

## Chouchin mini

Ionna Vautrin, 2013



Lacquered blown glass

LED retrofit  
1x8W GU10 PAR 16

⊕ ⊖ CE IP 20

	energy cl.	colours	code	vat excluded
<i>Chouchin mini 1</i>	A <sup>+</sup> , A, C	arancio	210271 53	213,00
<i>Chouchin mini 2</i>		verde	210272 40	235,00
<i>Chouchin mini 1 h. 5 m</i>		arancio	210271SP5 53	233,00
<i>Chouchin mini 2 h. 5 m</i>		verde	210272SP5 40	255,00

### Version without canopy with multiple canopy holder

<i>Chouchin mini 1</i>	A <sup>+</sup> , A, C	arancio	210271SR 53	204,00
<i>Chouchin mini 2</i>		verde	210272SR 40	226,00
<i>Chouchin mini 1 h. 5 m</i>		arancio	210271SR5 53	224,00
<i>Chouchin mini 2 h. 5 m</i>		verde	210272SR5 40	246,00

### Spare parts:

<i>Glass Chouchin mini 1</i>		arancio	210S021 53	118,00
<i>Glass Chouchin mini 2</i>		verde	210S022 40	118,00

### Accessories:

<i>Decentralization kit</i> for steel cables		KIT DEC B	28,00
	for steel cables + canopy	KIT DEC F	49,00
	canopy for electrical dec.	KIT DEC M	86,00

### Colours:

*Chouchin mini 1* arancio,  
*Chouchin mini 2* verde



Special colours  
on request

### Weight:

*Chouchin mini 1*  
net kg 1,00

*Chouchin mini 2*  
net kg 1,10

LED retrofit light bulbs  
not included  
→ specifications p. 182

Multiple canopy  
→ specifications p. 112

Decentralization  
→ specifications p. 118

mini 1

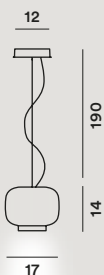

mini 2

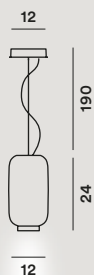

collection →

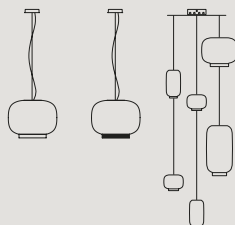

p. 078

p. 080

p. 112



**Chouchin**

Ionna Vautrin, 2011



Lacquered blown glass

**Chouchin**

LED retrofit  
1x12W E27 PAR 30  
Halo 1x150W E27  
Led Retrofit or Fluo  
1x25W E27



**Chouchin LED included**  
24W COB 2700° K  
2676 lm CRI>90 111 lm/W  
Dimmable LED version  
Possible configurations:  
On-Off/Push/DALI

On request on/off or  
dimmable  
24W COB 3000° K  
3385 lm CRI > 80 141 lm/W



	energy cl.	colours	code	vat excluded
<i>Chouchin 1</i>	A <sup>+</sup> , A, B, C	arancio	210071 53	406,00
<i>Chouchin 2</i>		verde	210072 40	392,00
<i>Chouchin 3</i>		grigio	210073 25	318,00
<i>Chouchin 1 h. 5 m</i>		arancio	210071SP5 53	448,00
<i>Chouchin 2 h. 5 m</i>		verde	210072SP5 40	434,00
<i>Chouchin 3 h. 5 m</i>		grigio	210073SP5 25	360,00
<i>Chouchin 1 LED</i>	A <sup>+</sup>	arancio	210071L 53	535,00
<i>Chouchin 2 LED</i>		verde	210072L 40	506,00
<i>Chouchin 3 LED</i>		grigio	210073L 25	447,00
<i>Chouchin 1 LED h. 5m</i>		arancio	210071L/5 53	554,00
<i>Chouchin 2 LED h. 5m</i>		verde	210072L/5 40	525,00
<i>Chouchin 3 LED.h. 5m</i>		grigio	210073L/5 25	466,00
<i>Chouchin 1 LED dimmable</i>	A <sup>+</sup>	arancio	210071LD 53	589,00
<i>Chouchin 2 LED dimmable</i>		verde	210072LD 40	560,00
<i>Chouchin 3 LED dimmable</i>		grigio	210073LD 25	501,00
<i>Chouchin 1 LED h. 5m dimmable</i>		arancio	210071LD/5 53	608,00
<i>Chouchin 2 LED h. 5m dimmable</i>		verde	210072LD/5 40	579,00
<i>Chouchin 3 LED. h. 5m dimmable</i>		grigio	210073LD/5 25	520,00

Colours:  
*Chouchin 1* arancio,  
*Chouchin 2* verde,  
*Chouchin 3* grigio



Special colours  
on request

Weight:  
*Chouchin 1*  
net kg 4,40

*Chouchin 2*  
net kg 2,90

*Chouchin 3*  
net kg 3,60

*Chouchin 1 LED*  
net kg 5,00

*Chouchin 2 LED*  
net kg 3,50

*Chouchin 3 LED*  
net kg 4,20

Halo, Fluo, LED retrofit  
light bulbs not included  
→ specifications p. 182

Multiple canopy  
→ specifications p. 112

Decentralization  
→ specifications p. 118

Tecnico — 2017

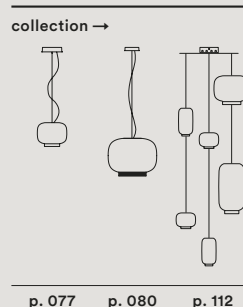
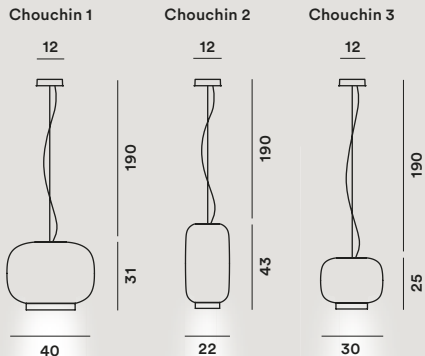

**Version without canopy with multiple canopy holder**

	energy cl.	colours	code	vat excluded
<i>Chouchin 1</i>	A <sup>+</sup> , A, B, C	arancio	210071SR 53	397,00
<i>Chouchin 2</i>		verde	210072SR 40	383,00
<i>Chouchin 3</i>		grigio	210073SR 25	309,00
<i>Chouchin 1 h. 5 m</i>		arancio	210071SR5 53	439,00
<i>Chouchin 2 h. 5 m</i>		verde	210072SR5 40	425,00
<i>Chouchin 3 h. 5 m</i>		grigio	210073SR5 25	351,00

**Spare parts:**

<i>Glass Chouchin 1</i>	arancio	210S001R1 53	300,00
<i>Glass Chouchin 2</i>	verde	210S002R1 40	271,00
<i>Glass Chouchin 3</i>	grigio	210S003R1 25	212,00

**Accessories:**

<i>Decentralization kit</i> for steel cables		KIT DEC B	28,00
	for steel cables + canopy	KIT DEC F	49,00
	canopy for electrical dec.	KIT DEC M	86,00

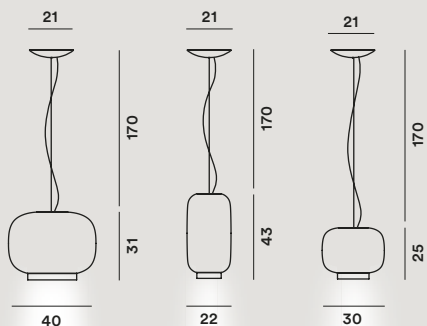
**Chouchin 1 LED    Chouchin 2 LED    Chouchin 3 LED**

**Chouchin reverse**

Ionna Vautrin, 2015



Lacquered blown glass

**Chouchin**  
LED retrofit or Fluo  
1x25W E27  
Halo 1x150W E27



**Chouchin LED included**  
24W COB 2700° K  
2676 lm CRI>90 111 lm/W  
Dimmable version  
Possible configurations:  
On-Off/Push/DALI

On request on/off or dimmable  
24W COB 3000° K  
3385 lm CRI > 80 141 lm/W



	energy cl.	colours	code	vat excluded
<i>Chouchin 1 reverse</i>	A <sup>+</sup> , A, B, C	bianco/arancio	210071 05	406,00
<i>Chouchin 2 reverse</i>		bianco/verde	210072 04	392,00
<i>Chouchin 3 reverse</i>		bianco/grigio	210073 02	318,00
<i>Chouchin 1 rev. h. 5 m</i>		bianco/arancio	210071SP5 05	448,00
<i>Chouchin 2 rev. h. 5 m</i>		bianco/verde	210072SP5 04	434,00
<i>Chouchin 3 rev. h. 5 m</i>		bianco/grigio	210073SP5 02	360,00
<i>Chouchin 1 reverse LED</i>	A <sup>+</sup>	bianco/arancio	210071L 05	535,00
<i>Chouchin 2 reverse LED</i>		bianco/verde	210072L 04	506,00
<i>Chouchin 3 reverse LED</i>		bianco/grigio	210073L 02	447,00
<i>Chouchin 1 reverse LED h. 5m</i>		bianco/arancio	210071L/5 05	554,00
<i>Chouchin 2 reverse LED h. 5m</i>		bianco/verde	210072L/5 04	525,00
<i>Chouchin 3 reverse LED h. 5m</i>		bianco/grigio	210073L/5 02	466,00
<i>Chouchin 1 reverse LED dimmable</i>		bianco/arancio	210071LD 05	589,00
<i>Chouchin 2 reverse LED dimmable</i>		bianco/verde	210072LD 04	560,00
<i>Chouchin 3 reverse LED dimmable</i>		bianco/grigio	210073LD 02	501,00
<i>Chouchin 1 reverse LED h. 5m dimmable.</i>		bianco/arancio	210071LD/5 05	608,00
<i>Chouchin 2 reverse LED h. 5m dimmable.</i>		bianco/verde	210072LD/5 04	579,00
<i>Chouchin 3 reverse LED h. 5m dimmable.</i>		bianco/grigio	210073LD/5 02	520,00

Colours:

*Chouchin reverse 1*  
bianco / arancio  
*Chouchin reverse 2*  
bianco / verde  
*Chouchin reverse 3*  
bianco / grigio

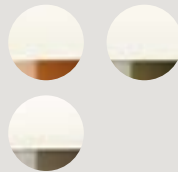

Special colours on request

Weight:

*Chouchin reverse 1*  
net kg 4,40

*Chouchin reverse 2*  
net kg 2,90

*Chouchin reverse 3*  
net kg 3,60

*Chouchin reverse 1 LED*  
net kg 5,00

*Chouchin reverse 2 LED*  
net kg 3,50

*Chouchin reverse 3 LED*  
net kg 4,20

Halo, Fluo, LED retrofit light bulbs not included → specifications p. 182

Multiple canopy → specifications p. 112

Decentralization → specifications p. 118

Tecnico — 2017

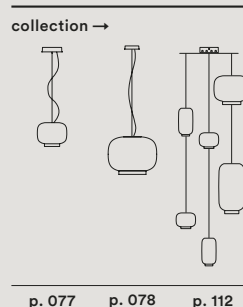
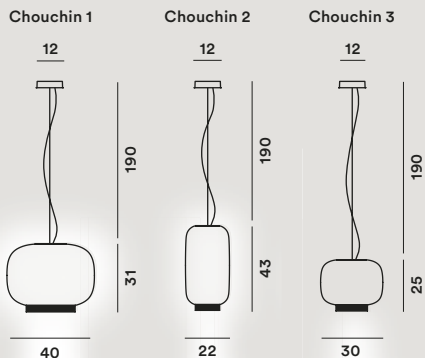

**Version without canopy with multiple canopy holder**

	energy cl.	colours	code	vat excluded
<i>Chouchin 1 reverse</i>	A <sup>+</sup> , A, B, C	bianco/arancio	210071SR 05	397,00
<i>Chouchin 2 reverse</i>		bianco/verde	210072SR 04	383,00
<i>Chouchin 3 reverse</i>		bianco/grigio	210073SR 02	309,00
<i>Chouchin 1 rev. h. 5 m</i>		bianco/arancio	210071SR5 05	439,00
<i>Chouchin 2 rev. h. 5 m</i>		bianco/verde	210072SR5 04	425,00
<i>Chouchin 3 rev. h. 5 m</i>		bianco/grigio	210073SR5 02	351,00

**Spare parts:**

<i>Glass Chouchin 1 reverse</i>	bianco/arancio	210S001R1 05	300,00
<i>Glass Chouchin 2 reverse</i>	bianco/verde	210S002R1 04	271,00
<i>Glass Chouchin 3 reverse</i>	bianco/grigio	210S003R1 02	212,00

**Accessories:**

<i>Decentralization kit</i> for steel cables	KIT DEC B	28,00
for steel cables + canopy	KIT DEC F	49,00
canopy for electrical dec.	KIT DEC M	86,00

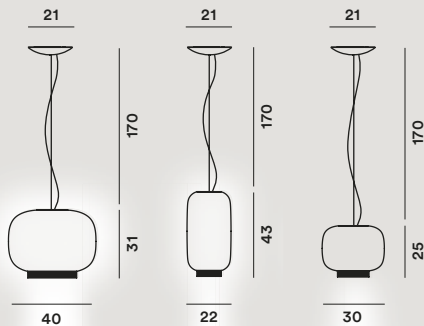
**Chouchin 1 LED    Chouchin 2 LED    Chouchin 3 LED**

**LED**

**Gregg**

Ludovica + Roberto  
Palomba, 2007



Blown acid-etched glass

**Gregg grande**  
LED retrofit or Fluo  
1x30W E27  
Halo 1x205W E27

**Gregg media**  
LED retrofit or Fluo  
1x25W E27  
Halo 1x150W E27

**Gregg piccola**  
LED retrofit 1x3,5W G9  
Halo 1x33W G9



**Gregg grande/media LED**  
LED included  
24W COB 2700° K  
2676 lm CRI>90 111 lm/W  
Dimmable version  
Possible configurations:  
On-Off/Push/DALI

On request on/off or  
dimmable  
24W COB 3000° K  
3385 lm CRI>80 141 lm/W



	energy cl.	colours	code	vat excluded
<b>Gregg grande</b>	A <sup>+</sup> , A, B, C	bianco	1680071 10	462,00
<b>Gregg grande h. 5 m</b>		bianco	1680071SP5 10	506,00
<b>Gregg media</b>	A <sup>+</sup> , A, B, C	bianco	168007 10	316,00
<b>Gregg media h. 5 m</b>		bianco	168007 10SP5	360,00
<b>Gregg piccola</b>	A <sup>+</sup> , A, C	bianco	1680072 10	141,00
<b>Gregg piccola h. 5 m</b>		bianco	1680072SP5 10	171,00
<b>Gregg media LED</b>	A <sup>+</sup>	bianco	168007L 10	407,00
<b>Gregg media LED dimmable</b>		bianco	168007LD 10	461,00
<b>Gregg media LED h. 5m</b>		bianco	168007L/5 10	426,00
<b>Gregg media LED h. 5m dimmable</b>		bianco	168007LD/5 10	480,00
<b>Gregg grande LED</b>		bianco	1680071L 10	553,00
<b>Gregg grande LED dimmable</b>		bianco	1680071LD 10	607,00
<b>Gregg grande LED h. 5m</b>		bianco	1680071L/5 10	572,00
<b>Gregg grande LED h. 5m dimmable</b>		bianco	1680071LD/510	626,00

Colours: bianco



Special colours  
on request

Weight:

**Gregg grande**  
net kg 5,60

**Gregg media**  
net kg 3,10

**Gregg piccola**  
net kg 0,70

**Gregg grande LED**  
net kg 6,20

**Gregg media LED**  
net kg 3,70

Halo, Fluo, LED retrofit  
light bulbs not included  
→ specifications p. 182

Multiple canopy  
→ specifications p. 112

Decentralization  
→ specifications p. 118

Tecnico — 2017

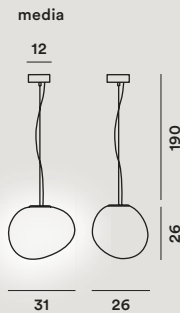
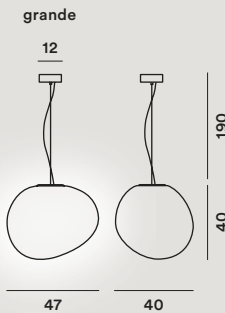



Version without canopy with multiple canopy holder

	energy cl.	colours	code	vat excluded
<i>Gregg media</i>	A <sup>+</sup> , A, B, C	bianco	168007SR 10	307,00
<i>Gregg media h. 5 m</i>		bianco	168007SR5 10	351,00
<i>Gregg piccola</i>	A <sup>+</sup> , A, C	bianco	1680072SR 10	132,00
<i>Gregg piccola h. 5 m</i>		bianco	1680072SR5 10	162,00

Spare parts:

<i>Glass Gregg grande</i>	bianco	168S001 10	318,00
<i>Glass Gregg media</i>	bianco	168S007R1 10	172,00
<i>Glass Gregg piccola</i>	bianco	168S00210	59,00

Accessories:

<i>Decentralization kit</i> for steel cables	KIT DEC B	28,00
<i>Gregg grande/media</i> for steel cables + canopy	KIT DEC F	49,00
<i>Gregg piccola</i> for power cable	KIT DEC C	33,00
canopy for electrical dec.	KIT DEC M	86,00

grande LED

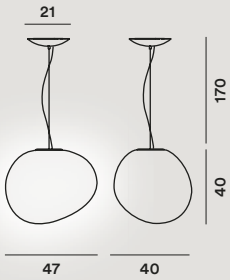

media LED

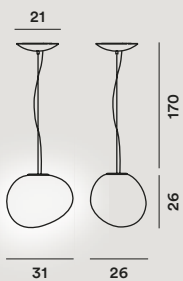

collection →

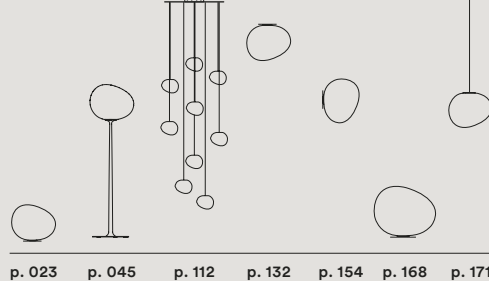

LED



**Giga-Lite**

Marc Sadler, 2004



Fiberglass fabric with carbonium thread, steel and nickel-plated metal

LED retrofit or Fluo  
3x20W E27  
Halo 3x77W E27

⊕ ⊖ CE IP 20

	energy cl.	colours	code	vat excluded	
<i>Giga-Lite</i>	A <sup>+</sup> , A, B, C	nero	139017 20	669,00	
<i>Giga-Lite h. 5 m</i>		nero	139017 20 SP5	703,00	
<b>Spare parts:</b>					
<i>Lampshade Giga-Lite</i>		nero	139S001 20	371,00	
<b>Accessories:</b>					
<i>Decentralization kit</i> for power cable			KIT DEC C	33,00	
			canopy for electrical dec.	KIT DEC M	86,00

Colours: nero



Weight:  
net kg 2,50

Halo, Fluo, LED retrofit  
light bulbs not included  
→ specifications p. 182

Decentralization  
→ specifications p. 118

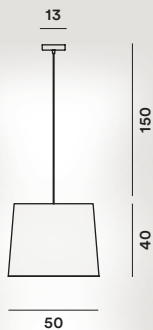

collection →

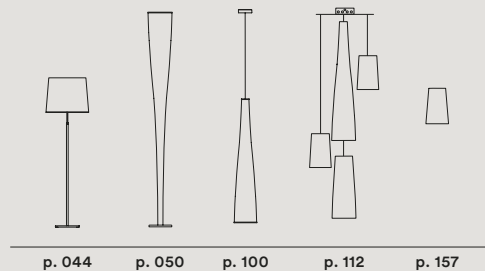

## Havana

Joseph Forakis, 1993



Injection moulded  
polyethylene and coated  
metal

LED retrofit or Fluo  
1x25W E27  
Halo 1x105W E27

⊕ ⊖ CE IP 20

*Havana doppia, tripla,  
quadrupla*

⊕ ⊖ CE IP 20

doppia tripla quadrupla

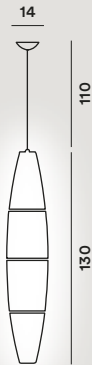
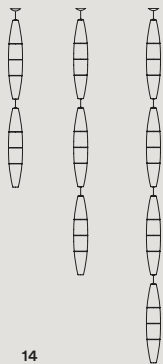

23

	energy cl.	colours	code	vat excluded
<i>Havana</i>	A <sup>+</sup> , A, B, C	bianco	0400072-R1 10	200,00
<i>Havana h. 5 m</i>		bianco	0400072SP5 10	234,00
<i>Havana doppia</i>		bianco	0400072SP2 10	910,00
<i>Havana tripla</i>		bianco	0400072SP3 10	1.320,00
<i>Havana quadrupla</i>		bianco	0400072SP4 10	1.730,00

### Version without canopy with multiple canopy holder

<i>Havana</i>	A <sup>+</sup> , A, B, C	bianco	0400072SR 10	191,00
<i>Havana h. 5 m</i>		bianco	0400072SR5 10	225,00

### Spare parts:

<i>Set lampshades Havana</i>	bianco	040S00 10	79,00
------------------------------	--------	-----------	-------

### Accessories:

<i>Decentralization kit</i> for power cable		KIT DEC C	33,00
canopy for electrical dec.		KIT DEC M	86,00

Colours: bianco



Special colours  
on request

Weight:  
net kg 1,90

Halo, Fluo, LED retrofit  
light bulbs not included  
→ specifications p. 182

Multiple canopy  
→ specifications p. 112

Decentralization  
→ specifications p. 118

collection →

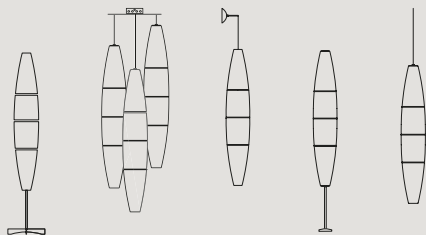

p. 045

p. 112

p. 155

p. 169

p. 172

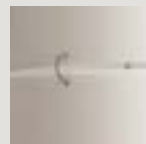

**Jamaica**

Marc Sadler, 2011



	energy cl.	colours	code	vat excluded
<i>Jamaica</i>	A <sup>+</sup> , A	bianco	225007 10	1.105,00
<i>Jamaica h. 5 m</i>		bianco	225007SP5 10	1.157,00
<i>Jamaica dimmable</i>	A <sup>+</sup> , A	bianco	225007DM 10	1.210,00
<i>Jamaica dimmable h. 5 m</i>		bianco	25007DMSP510	1.262,00
<b>Spare parts:</b>				
<i>Set lampshades Jamaica</i>		bianco	225S00 10	545,00
<b>Accessories:</b>				
<i>Decentralization kit</i>	canopy for electrical dec.		KIT DEC M	86,00

Paper tape coupled with techno polymer, PMMA and coated metal

Fluo 2x80W max. G5

Multiwatt ballast 35/49/80

Dimmable version  
Possible configurations:  
On-Off/Push/DALI

⊕ ⚡ CE IP 20

Colours: bianco



Weight:  
net kg 6,00

Fluo light bulbs  
not included  
→ specifications p. 182

Decentralization  
→ specifications p. 118

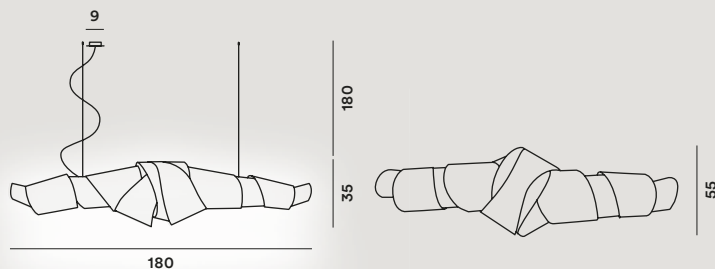

## Le Soleil

Vincente Garcia Jimenez,  
2009



Injection moulded  
polycarbonate and coated  
metal

*Le Soleil*  
LED retrofit o Fluo  
3x25W E27  
Halo 3x70W E27 +  
LED retrofit 1x8W GU10 PAR 16

⊕ ⚡ CE IP 20

	energy cl.	colours	code	vat excluded
<i>Le Soleil</i>	A <sup>+</sup> , A, C	bianco	181007 10	723,00
		rosso	181007 63	
		acquamarina*	181007 34	
<i>Le Soleil h. 5 m</i>		bianco	181007SP5 10	756,00
		rosso	181007SP5 63	
		acquamarina*	181007SP5 34	

### Spare parts:

<i>Set lampshades Le Soleil</i>	bianco	181S00-R1 10	338,00
	rosso	181S00-R1 63	
	acquamarina*	181S00-R1 34	

### Accessories:

<i>Decentralization kit</i> for steel cables	KIT DEC B	28,00		
	for steel cables + canopy		KIT DEC F	49,00
	canopy for electrical dec.		KIT DEC M	86,00

\* limited stock available

Colours: bianco, rosso,

Weight:  
net kg 5,30

Halo, Fluo, LED retrofit  
light bulbs not included  
→ specifications p. 182



acquamarina\*  
limited stock available



Decentralization  
→ specifications p. 118

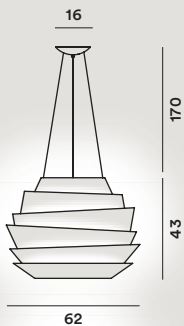

collection →



p. 159



**Lightweight**

Tom Dixon, 1995



	energy cl.	colours	code	vat excluded
<b>Lightweight</b>	A <sup>+</sup> , A, C	anodizzato	064007-R1 ZI	3.151,00
<b>Lightweight h. 5 m</b>		anodizzato	064007R1SP5ZI	3.262,00
<b>Spare parts:</b>				
<b>Glass</b>		bianco	061V01/I	23,00

Anodized metal

Halo 8x20W G4 12V  
LED retrofit 8x2W G4 12V

⊕ ⏚ CE IP 20

Colours: anodizzato



Weight:  
net kg 7,60

Halo, LED retrofit  
light bulbs  
not included  
→ specifications p. 182

Tecnico — 2017

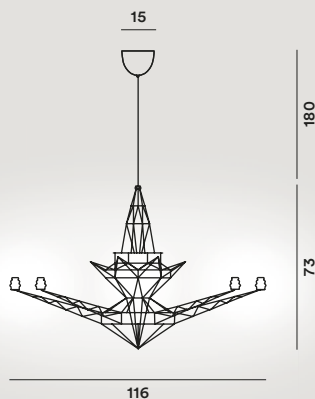

**Maki**

Nendo, 2011



Lacquered aluminium

LED retrofit  
1x8W GU10 PAR 16

IP 20

	energy cl.	colours	code	vat excluded
<b>Maki</b>	A <sup>+</sup> , A, C	bianco	219007 10	227,00
		grigio	219007 25	
<b>Maki h. 5 m</b>		bianco	219007SP5 10	254,00
		grigio	219007SP5 25	
<b>Version without canopy with multiple canopy holder</b>				
<b>Maki</b>	A <sup>+</sup> , A, C	bianco	219007SR 10	218,00
		grigio	219007SR 25	
<b>Maki h. 5 m</b>		bianco	219007SR5 10	245,00
		grigio	219007SR5 25	
<b>Accessories:</b>				
<b>Decentralization kit for power cable</b>			KIT DEC C	33,00
canopy for electrical dec.			KIT DEC M	86,00

Colours: bianco, grigio

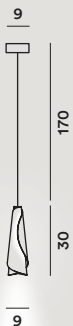
Weight:  
net kg 0,50Special colours  
on requestLED retrofit light  
bulbs not included  
→ specifications p. 182Multiple canopy  
→ specifications p. 112Decentralization  
→ specifications p. 118

collection →



p. 112

Bianco



Grigio



**New Buds**

Rodolfo Dordoni, 2007



Lacquered aluminium

LED retrofit or Fluo  
1x25W E27  
Halo 1x150W E27



	energy cl.	colours	code	vat excluded
<b>New Buds 1</b>	A+, A, C	grigio *	1780071 25	445,00
<b>New Buds 2</b>		avorio *	1780072 50	479,00
<b>New Buds 3</b>		ambra *	1780073 52	432,00

**Spare parts:**

<b>Glass New Buds 1</b>	grigio *	178S001R1 25	279,00
<b>Glass New Buds 2</b>	avorio *	178S002R1 50	313,00
<b>Glass New Buds 3</b>	ambra *	178S003R1 52	266,00

**Accessories:**

<b>Decentralization kit</b> for steel cables	KIT DEC B	28,00
for steel cables + canopy	KIT DEC F	49,00
canopy for electrical dec.	KIT DEC M	86,00

\* limited stock available

**Colours:**

**New Buds 1** grigio\*,  
**New Buds 2** avorio\*,  
**New Buds 3** ambra\*



**Weight:**

**New Buds 1**  
net kg 3,20

**New Buds 2**  
net kg 4,20

**New Buds 3**  
net kg 3,20

**Halo, Fluo, LED retrofit**  
light bulbs not included  
→ specifications p. 182

**Multiple canopy**  
→ specifications p. 112

**Decentralization**  
→ specifications p. 118

New Buds 1

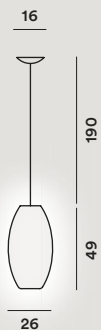

New Buds 2

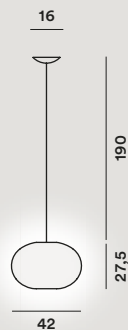

New Buds 3

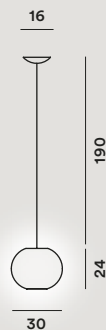

collection →

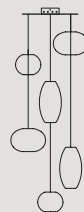

p. 112





## O-Space

Luca Nichetto  
e Gianpietro Gai, 2003



Expanded polyurethane and  
chrome metal

LED retrofit or Halo  
1x120W R7s

⊕ ⚡ CE IP 20

	energy cl.	colours	code	vat excluded	
<i>O-Space</i>	A+, A, C	bianco	127007 10	697,00	
<i>O-Space h. 5 m</i>		bianco	127007 10/SP5	750,00	
<b>Spare parts:</b>					
<i>Protection glass</i>		bianco	PIREX94/3/I	21,00	
<i>Protection disk</i>			PIREX D100/3I	30,00	
<b>Accessories:</b>					
<i>Decentralization kit</i> for steel cables			KIT DEC B	28,00	
			for steel cables + canopy	KIT DEC F	49,00
			canopy for electrical dec.	KIT DEC M	86,00

Colours: bianco



Special colours  
on request

Weight:  
net kg 4,40

Halo, LED retrofit  
light bulbs  
not included  
→ specifications p. 182

Decentralization  
→ specifications p. 118

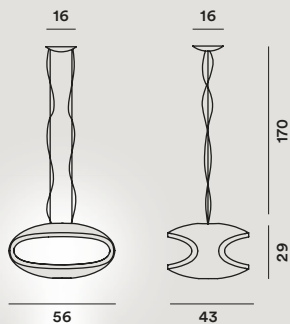

**Planet**

Changedesign, 2011



	energy cl.	colours	code	vat excluded	
<i>Planet grande</i>	A+, A, B, C	bianco	223017 10	1.007,00	
<i>Planet grande h. 5 m</i>		bianco	223017SP5 10	1.033,00	
<i>Planet piccola</i>	A+, A, B, C	bianco	223007 10	687,00	
<i>Planet piccola h. 5 m</i>		bianco	223007SP5 10	713,00	
<b>Spare parts:</b>					
<i>Lampshade Planet grande</i>		bianco	223S001-R110	655,00	
<i>Lampshade Planet piccola</i>		bianco	223S00 10	335,00	
<b>Accessories:</b>					
<i>Decentralization kit</i> for steel cables			KIT DEC B	28,00	
			for steel cables + canopy	KIT DEC F	49,00
			canopy for electrical dec.	KIT DEC M	86,00

Polyethylene terephthalate and nylon

*Planet grande*  
LED retrofit or Fluo  
1x25W E27  
Halo 1x150W E27

*Planet piccola*  
LED retrofit or Fluo  
1x25WE27  
Halo 1x105W E27



Colours: bianco



Weight:  
*Planet grande*  
net kg 2,50

*Planet piccola*  
net kg 2,00

Halo, Fluo, LED retrofit  
light bulbs not included  
→ specifications p. 182

Decentralization  
→ specifications p. 118

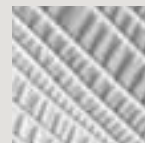
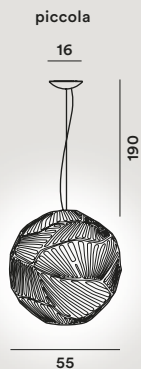
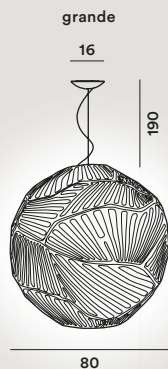

**Plass grande**

Luca Nichetto, 2011

**LED**

Rotational moulded  
polycarbonate and  
aluminium

*Plass LED* Included  
30W Lite-on 3000° K  
2500 lm CRI>80 84 lm/W  
+ 1x9,5W 2700° K 650 lm  
E27 PAR 30"

*Plass*  
Halo or LED retrofit  
6x60W G9  
+ 1x100W E27 PAR 30 or  
1x9,5W E27 PAR

Double switch



	energy cl.	colours	code	vat excluded	
<i>Plass LED</i>	A+, A	grigio	2240071L 25	2.672,00	
		azzurro	2240071L 30		
<i>Plass</i>	A+, A, C	grigio	2240071 25	2.252,00	
		azzurro	2240071 30		
<b>Spare parts:</b>		grigio	224S001 25	1.076,00	
<i>Lampshade Plass</i>		azzurro	224S001 30		
<b>Accessories:</b>					
<i>Decentralization kit</i> for steel cables			KIT DEC B	28,00	
			for steel cables + canopy	KIT DEC F	49,00
			canopy for electrical dec.	KIT DEC M	86,00

Colours: grigio, azzurro

Weight:  
net kg 23,00

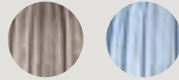

Special colours  
on request

Halo, LED retrofit  
light bulbs not included  
→ specifications p. 182

Decentralization  
→ specifications p. 118

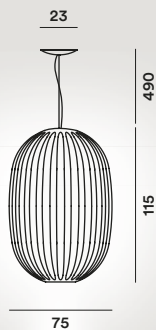

collection →

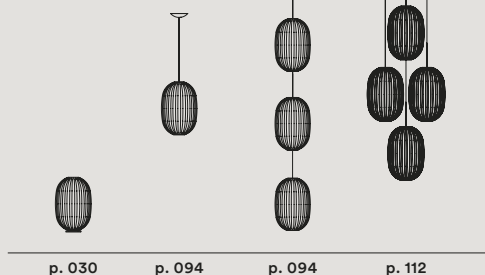

**Plass media**

Luca Nichetto, 2015



Rotational moulded polycarbonate and steel

LED retrofit or Fluo  
1x20W E27+1x8W GU10  
Halo 1x116W E27  
+ 1x75W GU10



doppia tripla quadrupla

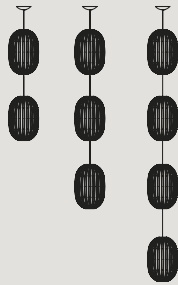

34

	energy cl.	colours	code	vat excluded
<i>Plass media E27+GU10</i>	A+, A, B, C	grigio	2240072 25	475,00
		azzurro	2240072 30	
<i>Plass media h. 5 m E27+GU10</i>	A+, A, B, C	grigio	2240072SP5 25	513,00
		azzurro	2240072SP5 30	
<i>Plass media 1 x E27</i>	A+, A, B, C	grigio	2240172 25	391,00
		azzurro	2240172 30	
<i>Plass media h. 5 m 1 x E27</i>	A+, A, B, C	grigio	2240172SP5 25	429,00
		azzurro	2240172SP5 30	
<i>Plass media doppia</i>		grigio	2240072/2 25	1.026,00
		azzurro	2240072/2 30	
<i>Plass media tripla</i>		grigio	2240072/3 25	1.470,00
		azzurro	2240072/3 30	
<i>Plass media quadrupla</i>		grigio	2240072/4 25	1.914,00
		azzurro	2240072/4 30	

**Version without canopy with multiple canopy holder**

<i>Plass media E27+GU10</i>	grigio	2240072SR 25	455,00
	azzurro	2240072SR 30	
<i>Plass media h. 5 m E27+GU10</i>	grigio	2240072SR5 25	493,00
	azzurro	2240072SR5 30	
<i>Plass media 1 x E27</i>	grigio	2240172SR 25	371,00
	azzurro	2240172SR 30	
<i>Plass media h. 5 m 1 x E27</i>	grigio	2240172SR5 25	409,00
	azzurro	2240172SR5 30	

**Spare parts:**

<i>Lampshade Plass media</i>	grigio	224S002 25	241,00
	azzurro	224S002 30	

Colours: grigio, azzurro

Weight:  
net kg 3,50

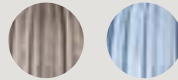

Special colours  
on request

Halo, Fluo LED retrofit  
light bulbs not included  
→ specifications p. 182

Multiple canopy  
→ specifications p. 112

Decentralization  
→ specifications p. 118

collection →

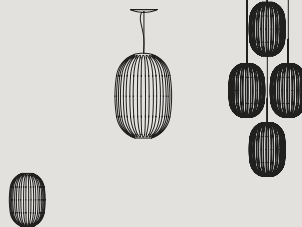

p. 030

p. 093

p. 112



**Spokes +  
Spokes 2 large**

Garcia Cumini, 2015 - 2016



Varnished steel and aluminium

LED Included  
38,2W (32,7 Cob + 5,5 High power) 2700° K 3264 lm CRI>90 83 lm/W

Dimmable version  
Possible configurations:  
On-Off/Push/DALI



	energy cl.	colours	code	vat excluded
<b>Spokes 1</b>	A	bianco	2640071 10	855,00
		giallo	2640071 55	
<b>Spokes 1 h. 5 m</b>		bianco	2640071SP5 10	885,00
		giallo	2640071SP5 55	
<b>Spokes 1 dimmable</b>		bianco	2640071D 10	914,00
		giallo	2640071D 55	
<b>Spokes 1 h. 5 m dimmable</b>		bianco	2640071D5 10	944,00
		giallo	2640071D5 55	
<b>Spokes 2</b>	A	bianco	2640072 10	840,00
		giallo	2640072 55	
<b>Spokes 2 h. 5 m</b>		bianco	2640072SP5 10	870,00
		giallo	2640072SP5 55	
<b>Spokes 2 dimmable</b>		bianco	2640072D 10	899,00
		giallo	2640072D 55	
<b>Spokes 2 h. 5 m dimmable</b>		bianco	2640072D5 10	929,00
		giallo	2640072D5 55	
<b>Accessories:</b>				
<b>Decentralization kit for steel cables</b>			KIT DEC B	28,00

Colours: bianco, giallo

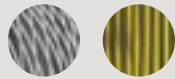

Special colours on request

Weight:  
**Spokes 1**  
net kg 4,40

**Spokes 2**  
net kg 4,40

**Spokes 2 Large**  
net kg 6,00

Decentralization  
→ specifications p. 118

Spokes 1



Spokes 2

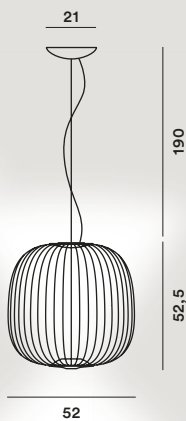

Spokes 2 large

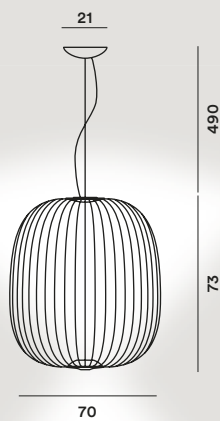

**Rituals + Rituals xl**

Ludovica + Roberto  
Palomba, 2013-2015



Blown engraved satin glass  
and lacquered metal

*Rituals 1-2-3 E27*  
LED retrofit or Fluo 1x15W  
Halo 1x70W

*Rituals 1-2-3 halogen G9 \**  
Halo or LED retrofit 1x60W

*Rituals xl*  
LED retrofit or Fluo  
1x25W E27  
Halo 1x150W E27

*Rituals xl LED* included  
24W COB 2700° K  
2676 lm CRI>90 111 lm/W  
Dimmable version  
Possible configurations:  
On-Off/Push/DALI

On request on/off or  
dimmable  
24W COB 3000° K  
3385 lm CRI>80 141 lm/W



	energy cl.	colours	code	vat excluded
<i>Rituals 1 E27</i>	A <sup>+</sup> , A, C	bianco	2440071E 10	356,00
<i>Rituals 1 G9 *</i>	A <sup>+</sup> , A, C	bianco	2440071G 10	373,00
<i>Rituals 2 E27</i>	A <sup>+</sup> , A, C	bianco	2440072E 10	356,00
<i>Rituals 2 G9 *</i>	A <sup>+</sup> , A, C	bianco	2440072G 10	373,00
<i>Rituals 3 E27</i>	A <sup>+</sup> , A, C	bianco	2440073E 10	301,00
<i>Rituals 3 G9 *</i>	A <sup>+</sup> , A, C	bianco	2440073G 10	318,00
<i>Rituals 1 E27 h. 5 m</i>	A <sup>+</sup> , A, C	bianco	2440071ESP510	386,00
<i>Rituals 1 G9 h. 5 m *</i>	A <sup>+</sup> , A, C	bianco	2440071GSP510	403,00
<i>Rituals 2 E27 h. 5 m</i>	A <sup>+</sup> , A, C	bianco	2440072ESP510	386,00
<i>Rituals 2 G9 h. 5 m *</i>	A <sup>+</sup> , A, C	bianco	2440072GSP510	403,00
<i>Rituals 3 E27 h. 5 m</i>	A <sup>+</sup> , A, C	bianco	2440073ESP510	331,00
<i>Rituals 3 G9 h. 5 m *</i>	A <sup>+</sup> , A, C	bianco	2440073GSP510	348,00
<i>Rituals xl</i>	A <sup>+</sup> , A, C	bianco	2440074 10	496,00
<i>Rituals xl h. 5 m</i>	A <sup>+</sup> , A, C	bianco	2440074SP5 10	525,00
<i>Rituals xl LED</i>	A <sup>+</sup>	bianco	2440074L 10	550,00
<i>Rituals xl LED dimmerabile</i>	A <sup>+</sup>	bianco	2440074LD 10	604,00
<i>Rituals xl LED h. 5m</i>	A <sup>+</sup>	bianco	2440074L/5 10	569,00
<i>Rituals xl LED h. 5m dimm.</i>	A <sup>+</sup>	bianco	2440074LD/510	623,00

\* G9 version limited stock available

Colours: bianco



Weight:  
*Rituals 1*  
net kg 3,80

*Rituals 2*  
net kg 4,00

*Rituals 3*  
net kg 1,50

*Rituals xl*  
net kg 5,90

Halo, Fluo, LED retrofit  
light bulbs not included  
→ specifications p. 182

Multiple canopy  
→ specifications p. 112

Decentralization  
→ specifications p. 118

Tecnico — 2017

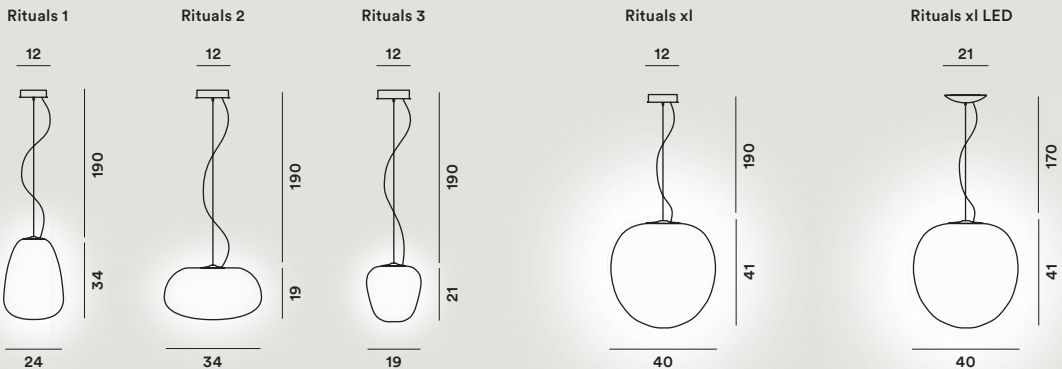

---

**Version without canopy with multiple canopy holder**

	energy cl.	colours	code	vat excluded
<i>Rituals 1 E27</i>	A <sup>+</sup> , A, B, C	bianco	2440071ESR 10	347,00
<i>Rituals 1 G9 *</i>	A <sup>+</sup> , A, C	bianco	2440071GSR 10	364,00
<i>Rituals 2 E27</i>	A <sup>+</sup> , A, B, C	bianco	2440072ESR 10	347,00
<i>Rituals 2 G9 *</i>	A <sup>+</sup> , A, C	bianco	2440072GSR 10	364,00
<i>Rituals 3 E27</i>	A <sup>+</sup> , A, B, C	bianco	2440073ESR 10	292,00
<i>Rituals 3 G9 *</i>	A <sup>+</sup> , A, C	bianco	2440073GSR 10	309,00
<i>Rituals xl</i>	A <sup>+</sup> , A, B, C	bianco	2440074SR 10	487,00
<i>Rituals 1 E27 h. 5 m</i>	A <sup>+</sup> , A, B, C	bianco	2440071ESR510	377,00
<i>Rituals 1 G9 h. 5 m *</i>	A <sup>+</sup> , A, C	bianco	2440071GSR510	394,00
<i>Rituals 2 E27 h. 5 m</i>	A <sup>+</sup> , A, B, C	bianco	2440072ESR510	377,00
<i>Rituals 2 G9 h. 5 m *</i>	A <sup>+</sup> , A, C	bianco	2440072GSR510	394,00
<i>Rituals 3 E27 h. 5 m</i>	A <sup>+</sup> , A, B, C	bianco	2440073ESR510	322,00
<i>Rituals 3 G9 h. 5 m *</i>	A <sup>+</sup> , A, C	bianco	2440073GSR510	339,00
<i>Rituals xl h. 5 m</i>	A <sup>+</sup> , A, B, C	bianco	2440074SR5 10	516,00

---

**Spare parts:**

<i>Glass Rituals 1</i>	bianco	244S001 10	222,00
<i>Glass Rituals 2</i>	bianco	244S002 10	222,00
<i>Glass Rituals 3</i>	bianco	244S003 10	167,00
<i>Glass Rituals xl</i>	bianco	244S004 10	315,00

---

**Accessories:**

<i>Decentralization kit</i> for steel cables	KIT DEC B	28,00
for steel cables + canopy	KIT DEC F	49,00
canopy for electrical dec.	KIT DEC M	86,00

\* G9 version limited stock available

---

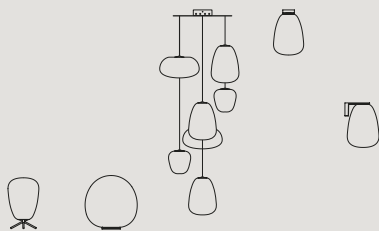
 collection →

p. 032

p. 033

p. 112

p. 135

p. 162

Rituals xl LED

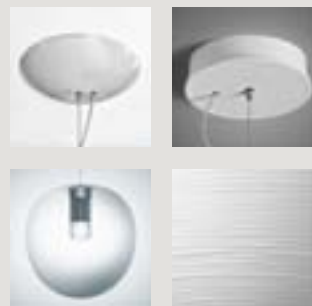

## Supernova

Ferruccio Laviani, 2000



	energy cl.	colours	code	vat excluded
<i>Supernova</i>	A+, A, B, C	alluminio	102007 20	1.120,00
		fucsia	102007 66	
<i>Supernova h. 5 m</i>		alluminio	102007SP5 20	1.171,00
		fucsia	102007SP5 66	
<i>Supernova xl</i>	A+, A, B, C	alluminio	102007SP7 20	5.377,00
on request		fucsia	102007SP7 66	

### Accessories:

<i>Decentralization kit</i> for steel cables	KIT DEC B	28,00
for steel cables + canopy	KIT DEC F	49,00
canopy for electrical dec.	KIT DEC M	86,00

Lacquered or natural aluminium

LED retrofit or Fluo  
1x23W E27

White globe bulb  
recommended  
Ø 12 cm

⊕ ⊖ CE IP 20

Colours: alluminio, fucsia



Special colours  
on request

Weight:  
*Supernova*  
net kg 8,00

*Supernova xl*  
net kg 19,50

Fluo, LED retrofit light  
bulbs not included  
→ specifications p. 182

Decentralization  
→ specifications p. 118

Supernova

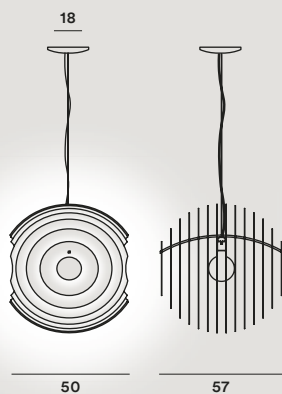

Supernova xl

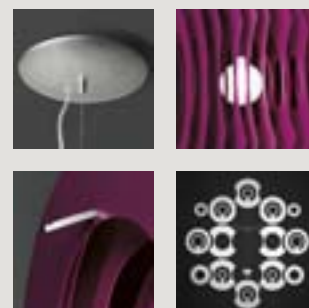
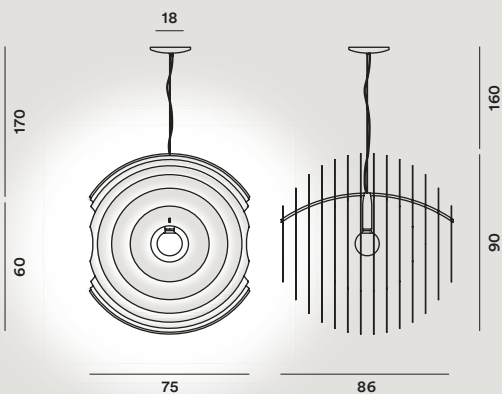



## Tartan

Ludovica + Roberto  
Palomba, 2015

LED



Blown acid-etched glass  
with reliefs

**Tartan E27**  
LED retrofit or Fluo  
1x25W E27  
Halo 1x150W E27

**Tartan LED** included  
24W COB 2700° K  
2676 lm CRI>90 111 lm/W  
Dimmable version  
Possible configurations:  
On-Off/Push/DALI

On request on/off or  
dimmable  
24W COB 3000° K  
3385 lm CRI>80 141 lm/W

⊕ CE IP 20

	energy cl.	colours	code	vat excluded
<b>Tartan E27</b>	A+, A, B, C	bianco	273007 10	408,00
		grigio	273007 24	
<b>Tartan E27 h. 5 m</b>		bianco	273007/5 10	437,00
		grigio	273007/5 24	
<b>Tartan LED</b>	A+	bianco	273007L 10	462,00
		grigio	273007L 24	
<b>Tartan LED h. 5 m</b>		bianco	273007L/5 10	481,00
		grigio	273007L/5 24	
<b>Tartan LED dimmable</b>	A+	bianco	273007LD 10	516,00
		grigio	273007LD 24	
<b>Tartan LED dimmable h. 5 m</b>		bianco	273007LD/5 10	535,00
		grigio	273007LD/5 24	

### Version without canopy with multiple canopy holder

<b>Tartan E27</b>	A+, A, B, C	bianco	273007SR 10	398,00
		grigio	273007SR 24	
<b>Tartan E27 h. 5 m</b>		bianco	273007SR5 10	427,00
		grigio	273007SR5 24	

### Spare parts:

<b>lampshade Tartan</b>	bianco	273S00 10	227,00
	grigio	273S00 24	

### Accessories:

<b>Decentralization kit</b> for steel cables		KIT DEC B	28,00
	for steel cables + canopy	KIT DEC F	49,00
	canopy for electrical dec.	KIT DEC M	86,00

Colours: bianco, grigio

Weight  
net kg 4,60

Halo, Fluo, LED retrofit  
light bulbs not included  
→ specifications p. 182

Multiple canopy  
→ specifications p. 112

Decentralization  
→ specifications p. 118

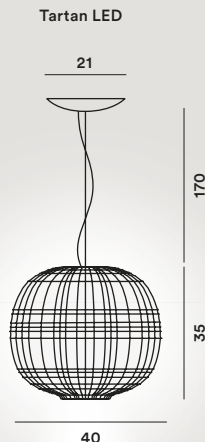
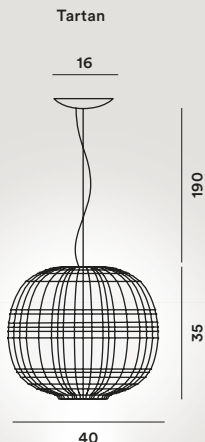

## Tite

Marc Sadler, 2000



Fiberglass fabric with carbonium thread and nickel-plated steel

LED retrofit or Fluo  
1x25W E27

Halo 1x116W E27

⊕ ⊖ CE IP 20

	energy cl.	colours	code	vat excluded
<i>Tite 1</i>	A <sup>+</sup> , A, B, C	nero	111017 20	477,00
<i>Tite 1 h. 5 m</i>		nero	111017SP5 20	503,00
<i>Tite 2</i>		nero	111027 20	370,00
<i>Tite 2 h. 5 m</i>		nero	111027SP5 20	396,00

### Version without canopy with multiple canopy holder

<i>Tite 1</i>	A <sup>+</sup> , A, B, C	nero	111017SR 20	464,00
<i>Tite 1 h. 5 m</i>		nero	111017SR5 20	490,00
<i>Tite 2</i>		nero	111027SR 20	357,00
<i>Tite 2 h. 5 m</i>		nero	111027SR5 20	383,00

### Spare parts:

<i>Lampshade Tite 1</i>	nero	111S001 20	343,00
<i>Lampshade Tite 2</i>	nero	111S002 20	245,00

### Accessories:

<i>Decentralization kit</i> for power cable		KIT DEC C	33,00
	canopy for electrical dec.	KIT DEC M	86,00

Colours: nero



Weight:

*Tite 1*  
net kg 1,40

*Tite 2*  
net kg 1,00

Halo, Fluo, LED retrofit  
light bulbs not included  
→ specifications p. 182

Multiple canopy  
→ specifications p. 112

Decentralization  
→ specifications p. 118

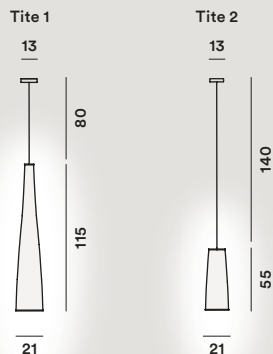

collection →

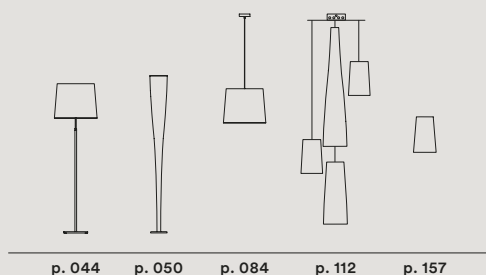

**Tress grande**

Marc Sadler, 2009



Coated fibreglass-based composite material, chromed metal and aluminium

**Tress grande LED Included**  
35W Mid power 3000°K  
3665 lm CRI > 90 104,4 lm/W  
Dimmable version  
Possible configurations:  
On-Off/Push/DALI

**Tress grande**  
LED retrofit or Halo  
1x160W R7s

On request dimmable LED version  
Possible configurations:  
On-Off/Push/DALI



	energy cl.	colours	code	vat excluded
<b>Tress grande LED</b>	A+	bianco	182007L 10	1.180,00
		nero	182007L 20	
		cremisi	182007L 67	
		greige	182007L 25	
		indaco	182007L 87	
<b>Tress grande LED dimmable</b>	A+	bianco	182007LD 10	1.247,00
		nero	182007LD 20	
		cremisi	182007LD 67	
		greige	182007LD 25	
		indaco	182007LD 87	
<b>Tress grande LED h. 5 m</b>		bianco	182007LSP5 10	1.232,00
		nero	182007LSP5 20	
		cremisi	182007LSP5 67	
		greige	182007LSP5 25	
		indaco	182007LSP5 87	
<b>Tress grande LED h. 5 m dimmable</b>		bianco	182007LD5 10	1.299,00
		nero	182007LD5 20	
		cremisi	182007LD5 67	
		greige	182007LD5 25	
		indaco	182007LD5 87	
<b>Tress grande</b>	A+, A, C	bianco	182007 10	766,00
		nero	182007 20	
		cremisi	182007 67	
		greige	182007 25	
		indaco	182007 87	
<b>Tress grande h. 5 m</b>		bianco	182007SP5 10	818,00
		nero	182007SP5 20	
		cremisi	182007SP5 67	
		greige	182007SP5 25	
		indaco	182007SP5 87	
<b>Spare parts:</b>				
<b>Lampshade Tress grande</b>		bianco	182S04 10	462,00
		nero	182S04 20	
		cremisi	182S04 67	
		greige	182S04 25	
		indaco	182S04 87	
<b>Accessories:</b>				
<b>Decentralization kit</b> for steel cables			KIT DEC B	28,00

Colours: bianco, nero, cremisi, greige, indaco

Weight: LED net kg 3,10

Halo, LED retrofit light bulbs not included → specifications p. 182



Halogen net kg 3,90

Decentralization → specifications p. 118

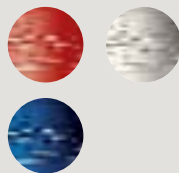

Special colours on request

collection →

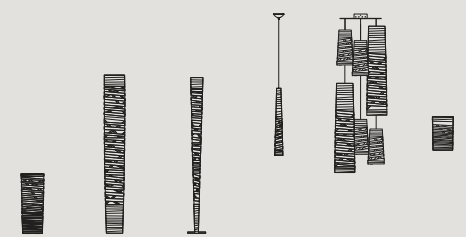

p. 033 p. 053 p. 054 p. 104 p. 112 p. 164



16 - 21 LED

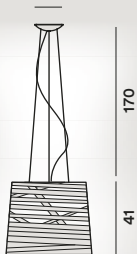

**Tress**

Marc Sadler, 2009



Coated fibreglass-based composite material and chromed metal

*Tress media* or *Tress piccola*  
LED retrofit  
1x9,5W E27 PAR 30

*Tress mini*  
LED retrofit  
1x8W GU10 PAR 16



	energy cl.	colours	code	vat excluded
<i>Tress media</i>	A <sup>+</sup> , A, C	bianco	182017 10	660,00
		nero	182017 20	
		cremisi	182017 67	
		greige	182017 25	
		indaco	182017 87	
<i>Tress media h. 5 m</i>		bianco	182017SP5 10	685,00
		nero	182017SP5 20	
		cremisi	182017SP5 67	
		greige	182017SP5 25	
		indaco	182017SP5 87	
<i>Tress piccola</i>	A <sup>+</sup> , A, C	bianco	182027 10	475,00
		nero	182027 20	
		cremisi	182027 67	
		greige	182027 25	
		indaco	182027 87	
<i>Tress piccola h. 5 m</i>		bianco	182027SP5 10	500,00
		nero	182027SP5 20	
		cremisi	182027SP5 67	
		greige	182027SP5 25	
		indaco	182027SP5 87	
<i>Tress mini</i>	A <sup>+</sup> , A, C	bianco	182037 10	403,00
		nero	182037 20	
		cremisi	182037 67	
		greige	182037 25	
		indaco	182037 87	
<i>Tress mini h. 5 m</i>		bianco	182037SP5 10	428,00
		nero	182037SP5 20	
		cremisi	182037SP5 67	
		greige	182037SP5 25	
		indaco	182037SP5 87	



Colours: bianco, nero, cremisi, greige, indaco

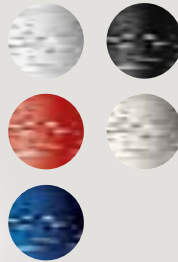

Weight:  
*Tress media*  
net kg 2,40

*Tress piccola*  
net kg 1,60

*Tress mini*  
net kg 1,10

LED retrofit light bulbs not included  
→ specifications p. 182

Multiple canopy  
→ specifications p. 112

Decentralization  
→ specifications p. 118



collection →

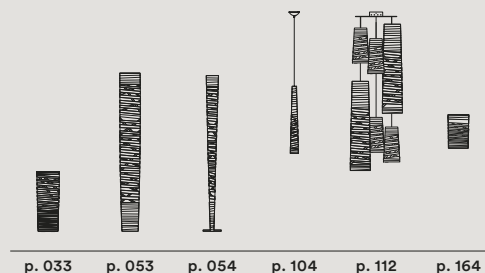

media/piccola



mini



Version without canopy with multiple canopy holder	energy cl.	colours	code	vat excluded
<b>Tress media</b>	A <sup>+</sup> , A, C	bianco	182017SR 10	<b>640,00</b>
		nero	182017SR 20	
		cremisi	182017SR 67	
		greige	182017SR 25	
		indaco	182017SR 87	
<b>Tress media h. 5 m</b>		bianco	182017SR5 10	<b>665,00</b>
		nero	182017SR5 20	
		cremisi	182017SR5 67	
		greige	182017SR5 25	
		indaco	182017SR5 87	
<b>Tress piccola</b>	A <sup>+</sup> , A, C	bianco	182027SR 10	<b>455,00</b>
		nero	182027SR 20	
		cremisi	182027SR 67	
		greige	182027SR 25	
		indaco	182027SR 87	
<b>Tress piccola h. 5 m</b>		bianco	182027SR5 10	<b>480,00</b>
		nero	182027SR5 20	
		cremisi	182027SR5 67	
		greige	182027SR5 25	
		indaco	182027SR5 87	
<b>Tress mini</b>	A <sup>+</sup> , A, C	bianco	182037SR 10	<b>383,00</b>
		nero	182037SR 20	
		cremisi	182037SR 67	
		greige	182037SR 25	
		indaco	182037SR 87	
<b>Tress mini h. 5 m</b>		bianco	182037SR5 10	<b>408,00</b>
		nero	182037SR5 20	
		cremisi	182037SR5 67	
		greige	182037SR5 25	
		indaco	182037SR5 87	
<b>Spare parts:</b>		<b>Lampshade Tress media</b>		<b>492,00</b>
		bianco	182S02 10	
		nero	182S02 20	
		cremisi	182S02 67	
		greige	182S02 25	
		<b>Lampshade Tress piccola</b>		<b>307,00</b>
		bianco	182S01 10	
		nero	182S01 20	
		cremisi	182S01 67	
		greige	182S01 25	
		<b>Lampshade Tress mini</b>		<b>282,00</b>
		bianco	182S0012 10	
		nero	182S0012 20	
		cremisi	182S0012 67	
		greige	182S0012 25	
<b>Accessories:</b>		<b>Decentralization kit</b> for steel cables		<b>28,00</b>
		for steel cables + canopy		<b>49,00</b>
		for power cable		<b>33,00</b>
		canopy for electrical dec.		<b>86,00</b>

Special colours  
on request

**Tress Stilo**

Marc Sadler, 2011



Coated fibreglass-based composite material, stainless steel and polycarbonate

LED retrofit  
1x8W GU10 PAR 16

⊕ ⚡ CE IP 20

	energy cl.	colours	code	vat excluded
<i>Tress Stilo</i>	A <sup>+</sup> , A, C	bianco	182047 10	315,00
		nero	182047 20	
<i>Tress Stilo h. 5 m</i>		bianco	182047SP5 10	340,00
		nero	182047SP5 20	

**Version without canopy with multiple canopy holder**

<i>Tress Stilo</i>	A <sup>+</sup> , A, C	bianco	182047SR 10	301,00
		nero	182047SR 20	
<i>Tress Stilo h. 5 m</i>		bianco	182047SR5 10	326,00
		nero	182047SR5 20	

**Accessories:**

<i>Decentralization kit</i> for power cable	KIT DEC C	33,00
canopy for electrical dec.	KIT DEC M	86,00

Colours: bianco, nero

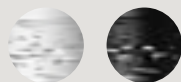

Special colours  
on request

Weight:  
net kg 0,50

LED retrofit light bulbs  
not included  
→ specifications p. 182

Multiple canopy  
→ specifications p. 112

Decentralization  
→ specifications p. 118



collection →

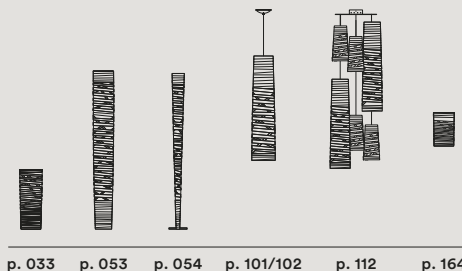

# Troag

Luca Nichetto, 2010



Curved plywood and PMMA

**Troag grande**  
Fluo 1x80W G5

**Troag media**  
Fluo 1x54W G5

**Troag piccola**  
Fluo 1x24W G5

On request dimmable version  
Possible configurations:  
On-Off/Push/DALI



	energy cl.	colours	code	vat excluded
<b>Troag grande</b>	A+, A	bianco	2050071 10	899,00
		nero	2050071 20	
		naturale	2050071 50	
<b>Troag media</b>	A+, A	bianco	205007 10	724,00
		nero	205007 20	
		naturale	205007 50	
<b>Troag media h. 5 m</b>	A+, A	bianco	205007SP5 10	755,00
		nero	205007SP5 20	
		naturale	205007SP5 50	
<b>Troag piccola</b>	A+, A	bianco	2050072 10	620,00
		nero	2050072 20	
		naturale	2050072 50	
<b>Troag piccola h. 5 m</b>	A+, A	bianco	2050072SP5 10	650,00
		nero	2050072SP5 20	
		naturale	2050072SP5 50	

**Accessories:**

<b>Decentralization kit</b>	canopy for electrical dec.	KIT DEC M	86,00
-----------------------------	----------------------------	-----------	-------

Colours: bianco, nero, naturale



Special colours on request

**Weight:**  
**Troag grande**  
net kg 3,50

**Troag media**  
net kg 2,80

**Troag piccola**  
net kg 1,80

**Fluo light bulbs**  
not included  
→ specifications p. 182

**Decentralization**  
→ specifications p. 118

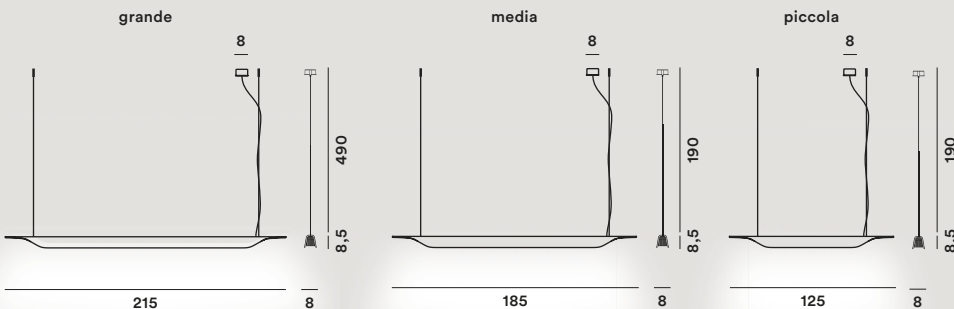

**Tropico**

Giulio Iacchetti, 2008



Injection moulded polycarbonate and chromed metal

**Tropico Vertical**  
Fluo 1x40W max 2G11  
Multiwatt electronic ballast  
24/36/40

**Tropico Sphera**  
Fluo 1x42W max GX24q-4  
Multiwatt electronic ballast  
26/32/42

**Tropico Ellipse**  
Fluo 1x42W max GX24q-4  
Multiwatt electronic ballast  
26/32/42



	energy cl.	colours	code	vat excluded
<b>Tropico Vertical</b>	A <sup>+</sup> , A	ghiaccio	179072 16	1.172,00
		avorio*	179072 50	
<b>Tropico Sphera</b>	A <sup>+</sup> , A	ghiaccio	179073 16	1.063,00
		avorio*	179073 50	
<b>Tropico Ellipse</b>	A <sup>+</sup> , A	ghiaccio	179074 16	954,00
<b>Tropico Vertical h. 5 m</b>		ghiaccio	179072 16 SP5	1.203,00
		avorio*	179072 50 SP5	
<b>Tropico Sphera h. 5 m</b>		ghiaccio	179073 16 SP5	1.094,00
		avorio*	179073 50 SP5	
<b>Tropico Ellipse h. 5 m</b>		ghiaccio	179074 16 SP5	985,00

**Spare parts:**

<b>Set Tropico Vertical</b>	ghiaccio	179S002 16	366,00
	avorio*	179S002 50	
<b>Set Tropico Sphera</b>	ghiaccio	179S003 16	372,00
	avorio*	179S003 50	
<b>Set Tropico Ellipse</b>	ghiaccio	179S004 16	335,00

**Accessories:**

<b>Set colour filters Tropico Vertical</b>	blu/arancio	179S172-R1	160,00
<b>Set colour filters Tropico Sphera</b>	blu/arancio	179S173-R1	76,00
<b>Set colour filters Tropico Ellipse</b>	blu/arancio	179S174-R1	68,00
<b>Decentralization kit</b> for steel cables		KIT DEC B	28,00
	for steel cables + canopy	KIT DEC F	49,00
	canopy for electrical dec.	KIT DEC M	86,00

\* limited stock available

Colours: ghiaccio,



avorio\*  
limited stock available



Weight:  
**Tropico Vertical**  
net kg 7,70

**Tropico Sphera**  
net kg 6,50

**Tropico Ellipse**  
net kg 6,50

Fluo light bulbs  
not included  
→ specifications p. 182

Decentralization  
→ specifications p. 118

Vertical

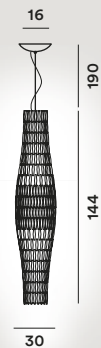

Sphera

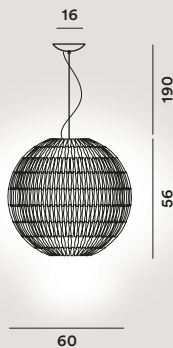

Ellipse





**Twice as Twiggy**

Marc Sadler, 2016



	energy cl.	colours	code	vat excluded
<i>Twice as Twiggy</i>	A+	bianco	275017 10	2.395,00
		nero	275017 20	
		greige	275017 25	
		cremisi	275017 67	
		indaco	275017 87	

**Spare parts:**

<i>Lampshade Twice as Twiggy</i>	bianco	275S001 10	1.918,00
	nero	275S001 20	
	greige	275S001 25	
	cremisi	275S001 67	
	indaco	275S001 87	

Coated fibreglass-based composite material, PMMA and aluminium

LED Included  
 81W (54 + 27 Mid-power)  
 3000° K 8517 lm  
 CRI>90 106 lm/W  
 Dimmable  
 Possible configurations:  
 On-Off/Push/DALI

⊕ CE IP 20

Colours: bianco, nero, cremisi, greige, indaco

Weight: net kg 8,40

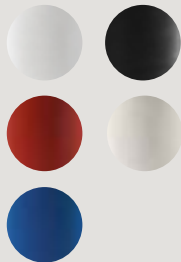

Special colours on request

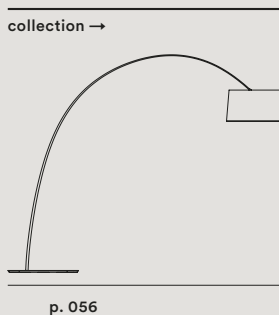
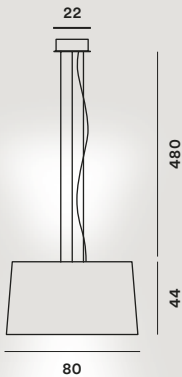

**Twiggy**

Marc Sadler, 2007



Coated fibreglass-based composite material, PMMA, and polycarbonate

LED retrofit or Fluo  
3x20W E27  
Halo 3x77W E27



	energy cl.	colours	code	vat excluded
<b>Twiggy grande</b>	A+, A, B, C	bianco	159007 10	697,00
		nero	159007 20	
<b>Twiggy grande h. 5 m</b>		bianco	159007 10SP5	689,00
		nero	159007 20SP5	
<b>Spare parts:</b>				
<b>Lampshade Twiggy grande</b>		bianco	159S10 10	464,00
		nero	159S10 20	
<b>Lower diffusor disk</b>			159R05	33,00
<b>Accessories:</b>				
<b>Decentralization kit</b>		for power cable		KIT DEC C
		canopy for electrical dec.		
				33,00
				86,00

Colours: bianco, nero

Weight:  
net kg 1,80

Halo, Fluo, LED retrofit  
light bulbs not included  
→ specifications p. 182



Special colours  
on request

Decentralization  
→ specifications p. 118

Tecnico — 2017

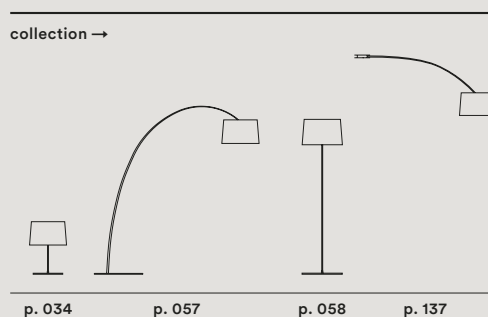
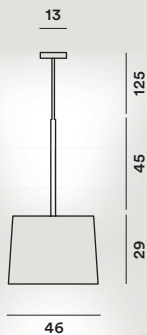

**Uto**

Lagranja Design, 2005



	energy cl.	colours	code	vat excluded
<b>Uto</b>	A <sup>+</sup> , A	bianco	142000 10	<b>349,00</b>
		giallo	142000 50	
		arancio	142000 53	

Thermoplastic elastomer and polycarbonate

LED retrofit or Fluo 1x15W E27  
Switch inside the flexible tube

IP 20

Colours: bianco, giallo, arancio



Special colours on request

Weight: net kg 2,00

Fluo, LED retrofit light bulbs not included  
→ specifications p. 182

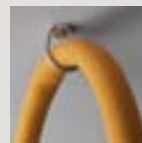
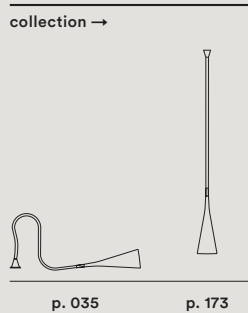
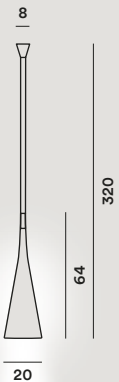

## Wave

Studio Baruffi & De Santi,  
2009



	energy cl.	colours	code	vat excluded
<i>Wave</i>	A <sup>+</sup> , A, C	bianco	185007 10	1.151,00
		alluminio	185007 77	
<i>Wave h. 5 m</i>	A <sup>+</sup> , A, C	bianco	185007SP5 10	1.193,00
		alluminio	185007SP5 77	
<b>Accessories:</b>				
<i>Decentralization kit</i>	canopy for electrical dec.		KIT DEC M	86,00

Lacquered aluminium

LED retrofit or Halo  
3x80W R7s

⊕ ⚡ CE IP 20

Colours: bianco,  
alluminio



Special colours  
on request

Weight:  
net kg 6,00

Halo, LED retrofit  
light bulbs not included  
→ specifications p. 182

Tecnico — 2017

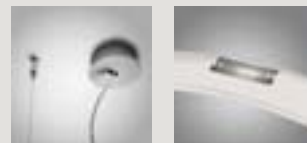
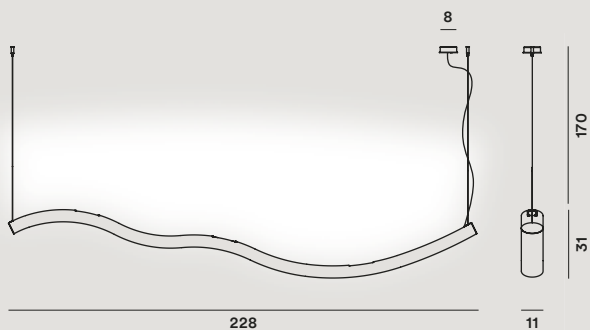

*Accessori, Accessories*

112 **Rosone multiplo tondo**

112 **Rosone multiplo lineare**

118 **Kit decentramento**

## Multiple canopies



### Round multiple canopy

Colour: white  
Laquered metal

Weight: net kg 9,00

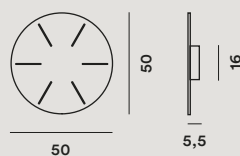

code: ROSONE01 10

vat excluded

415,00



### Linear multiple canopy 90 cm

Colour: white  
Laquered metal

Weight: net kg 7,00

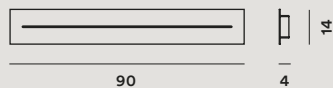

code: ROSONE02 10

vat excluded

349,00



## Linear multiple canopy 135 cm

Colour: white  
Laquered metal

Weight: net kg 10,00

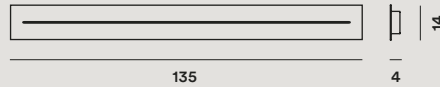

code: ROSONE03 10

vat excluded

464,00

Max refers  
to installation  
in staggered  
composition

Model	round	linear 90	linear 135
<i>Aplomb - Aplomb mini</i>	max 9	max 6	max 9
<i>Birdie grande</i>	max 6	max 6	max 9
<i>Birdie piccola</i>	max 9	max 6	max 9
<i>Buds / New Buds 1 ▲</i>	max 6	max 6	max 9
<i>Buds / New Buds 2 ▲</i>	max 6	max 4	max 6
<i>Buds / New Buds 3 ▲</i>	max 6	max 5	max 8
<i>Caboche piccola</i>	max 6	max 5	max 8
<i>Caiigo</i>	max 6	max 6	max 9
<i>Chouchin / reverse 1 ▲</i>	max 6	max 4	max 6
<i>Chouchin / reverse 2 ▲</i>	max 6	max 6	max 9
<i>Chouchin / reverse 3 ▲</i>	max 6	max 5	max 8
<i>Chouchin mini 1 - 2</i>	max 9	max 6	max 9
<i>Gregg media ▲</i>	max 6	max 5	max 8
<i>Gregg piccola</i>	max 9	max 6	max 9
<i>Havana</i>	max 6	max 6	max 9
<i>Maki</i>	max 9	max 6	max 9
<i>Plass media</i>	max 6	max 5	max 8
<i>Rituals 1</i>	max 6	max 6	max 9
<i>Rituals 2</i>	max 6	max 5	max 7
<i>Rituals 3</i>	max 9	max 6	max 9
<i>Rituals xl ▲</i>	max 5	max 4	max 5
<i>Tartan ▲</i>	max 5	max 4	max 5
<i>Tite 1 - Tite 2</i>	max 9	max 6	max 9
<i>Tress media - Tress piccola</i>	max 6	max 6	max 9
<i>Tress mini - Tress Stilo</i>	max 9	max 6	max 9

▲ excluded integrated LED version

Round multiple canopy

Aplomb + Aplomb mini



Birdie



Caboche piccola



Chouchin + Chouchin mini



Gregg



Havana





Round multiple canopy

Maki



Plass media



Tress



Tartan



Tite 2



Tress Stilo

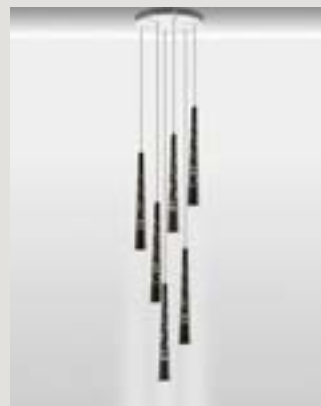

Linear multiple canopy

Aplomb + Aplomb mini



Birdie



Caboche piccola



Plass media



Gregg



Maki



## Linear multiple canopy

Rituals



Tartan



Tress



Tite 2



# Decentralization kit



## Kit B — Code: KIT DEC B

Decentralization kit, includes 3 support for steel cables.

For the models: Allegretto, Allegro, Behive, Big Bang, Buds, Caboche, Caiigo, Chouchin, Chouchin Reverse, Chouchin mini, Gregg grande / media, Le Soleil, New Buds, O-Space, Planet, Plass, Plass media, Rituals, Rituals XL, Supernova, Tartan, Tropico, Twice as Twiggy, Tress grande / media / piccola

Weight: net kg 0,01

	<u>vat excluded</u>
	<u>28,00</u>

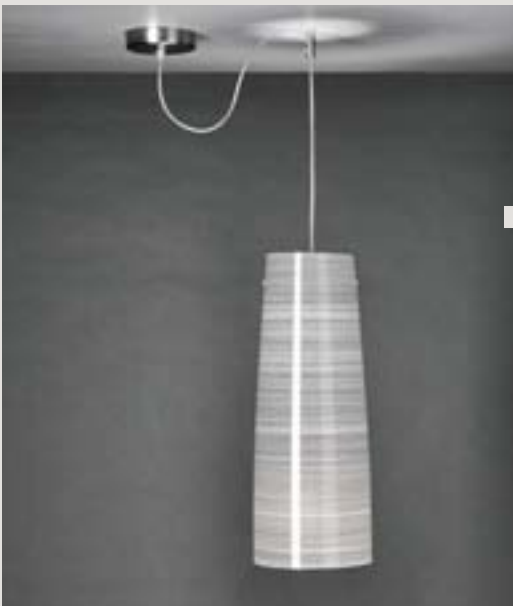

## Kit C — Code: KIT DEC C

Decentralization for power cable.

For the models: Aplomb, Aplomb large, Aplomb mini, Birdie, Giga-Lite, Gregg piccola, Havana, Maki, Tite, Tress mini, Tress stilo, Twiggy

Weight: net kg 0,01

	<u>vat excluded</u>
	<u>33,00</u>

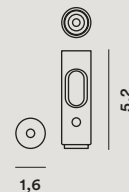

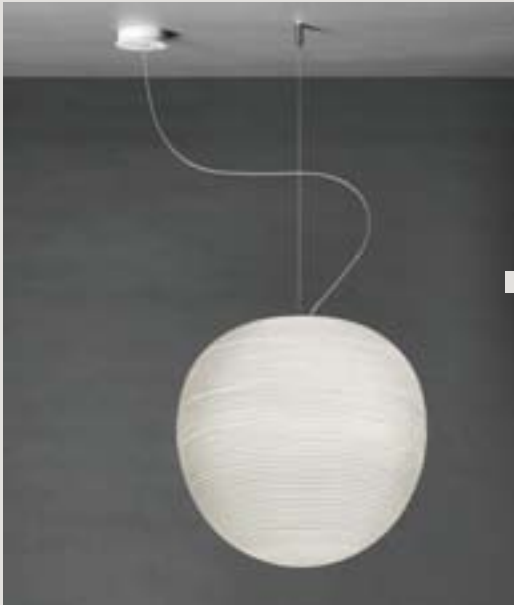

### Kit F — Code: KIT DEC F



Decentralization kit, includes 3 support for steel cables + spare canopy.

For the models: Allegretto, Allegro, Behive, Big Bang ▲, Buds ▲, Caboche ▲, Chouchin / reverse ▲, Chouchin mini, Gregg grande /media ▲, Le Soleil, New Buds, O-Space, Planet, Plass ▲, Plass media, Rituals, Rituals xl ▲, Supernova, Tartan ▲, Tropic, Tress grande ▲ /media / piccola.

▲ LED version excluded

Weight: net kg 0,03

vat excluded

49,00

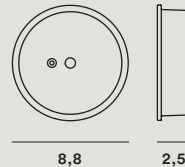

### Kit M — Code: KIT DEC M



Canopy electrical decentralization up to 4 lamps.

The kit M contains only the canopy, to compositions as picture order the necessary quantity of Kit B or Kit C.

For the models: Aplomb, Aplomb mini, Behive, Big Bang ▲, Birdie, Buds ▲, Caboche ▲, Chouchin / reverse ▲, Chouchin mini, Giga-Lite, Gregg ▲, Havana, Jamaica, Le Soleil, Maki, New Buds, O-Space, Planet, Plass ▲, Plass media, Rituals, Rituals XL ▲, Supernova, Tartan ▲, Tite, Tress ▲, Tress Stilo, Troag, Tropic, Twiggy, Wave.

▲ LED version excluded

Weight: net kg 0,01

vat excluded

86,00

vat included

86,00

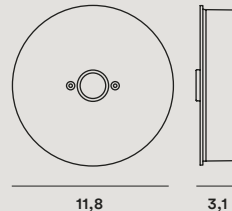



*Soffitto, Ceiling*

122 **Bahia +  
Bahia mini**

123 **Big Bang**

124 **Birdie**

126 **Blob S**

127 **Caboche**

128 **Circus**

129 **Ellepi**

130 **Falena**

131 **Folio**

132 **Gregg**

133 **Lumiere  
xxl + xxs**

134 **Nuage**

135 **Rituals**

136 **Tivu**

137 **Twiggy**

**Bahia + Bahia mini**

Lucidi e Pevere, 2010-2015



	energy cl.	colours	code	vat excluded
<i>Bahia fluo</i>	A <sup>+</sup> , A	bianco	196005 10	445,00
<i>Bahia LED</i>	A <sup>+</sup>	bianco	196005L 10	622,00
<i>Bahia LED dimmable</i>	A <sup>+</sup>	bianco	196005LD 10	671,00
<i>Bahia mini fluo</i>	A <sup>+</sup> , A	bianco	1960052 10	248,00
<i>Bahia mini fluo dimmable</i>	A <sup>+</sup> , A	bianco	1960052D 10	311,00
<i>Bahia mini LED</i>	A <sup>+</sup>	bianco	1960052L 10	399,00
<i>Bahia mini LED dimmable</i>	A <sup>+</sup>	bianco	1960052LD 10	450,00

Injection moulded polycarbonate

Colours: bianco

Weight:  
*Bahia*  
net kg 3,40

Fluo light bulbs  
not included  
→ specifications p. 182

*Bahia fluo*  
Fluo 1x40W + 1x22W 2GX13



*Bahia mini*  
net kg 2,00

*Bahia LED* included  
43W Mid-power 2850° K  
4210 lm CRI>90 97,9 lm/W  
Dimmable version Possible configurations:  
On-Off/Push/DALI

*Bahia mini fluo*  
Fluo 1x22W 2GX13  
Dimmable version  
Possible configurations:  
On-Off/Push/DALI

*Bahia mini LED* included  
21W Mid- power 2850° K  
2425 lm CRI>90 115 lm/W  
Dimmable version Possible configurations:  
On-Off/Push/DALI



Tecnico — 2017

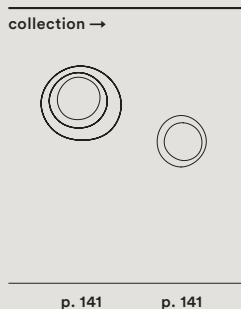
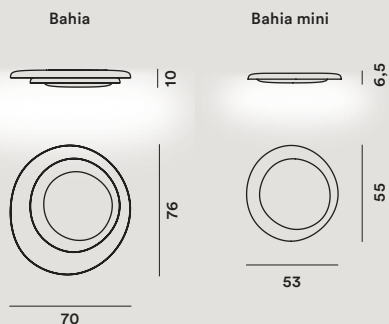



## Big Bang

Enrico Franzolini con  
Vicente Garcia Jimenez, 2005



Methacrylate and coated  
metal

LED retrofit or Halo  
1x120W R7s

⊕ ⚡ CE IP 20

	energy cl.	colours	code	vat excluded
<i>Big Bang</i>	A <sup>+</sup> , A, C	bianco	151005 10	429,00
		rosso	151005 63	445,00
<b>Spare parts:</b>				
<i>Set lampshades Big Bang</i>		bianco	151S05 10	254,00
		rosso	151S05 63	270,00
<i>Halogen protection glass</i>			PIREX94/4/I	21,00

Colours: bianco, rosso

Weight:  
net kg 3,00

Halo, LED retrofit  
light bulbs not included  
→ specifications p. 182



Special colours  
on request



23

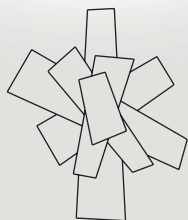

79

66

collection →

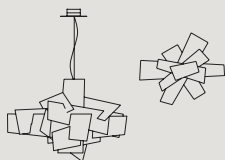

p. 068

p. 142



## Birdie

Ludovica + Roberto  
Palomba, 2012



Polycarbonate and coated aluminium

LED retrofit or Fluo  
1-3-6-9x20W E27  
Halo 1-3-6-9x70W E27

Different heights on request



	energy cl.	colours	code	vat excluded
<b>Birdie 1 *</b>	A+, A, B, C	bianco *	2210081 10	326,00
		grigio *	2210081 25	
		arancio *	2210081 53	
		amaranto *	2210081 65	
<b>Birdie 3</b>	A+, A, B, C	bianco	2210083 10	718,00
		grigio	2210083 25	
		arancio	2210083 53	
		amaranto	2210083 65	
<b>Birdie 6</b>	A+, A, B, C	bianco	2210086 10	1.350,00
		grigio	2210086 25	
		arancio	2210086 53	
		amaranto	2210086 65	
<b>Birdie 9</b>	A+, A, B, C	bianco	2210089 10	1.997,00
		grigio	2210089 25	
		arancio	2210089 53	
		amaranto	2210089 65	
<b>Spare parts:</b>				
<b>Lampshade Birdie</b>		bianco	221S002 10	46,00
		grigio	221S002 25	
		arancio	221S002 53	
		amaranto	221S002 65	

\* Limited stock available

Colours: bianco, grigio, arancio, amaranto



Special colours on request

Weight:  
**Birdie 1**  
net kg 1,50

**Birdie 3**  
net kg 3,70

**Birdie 6**  
net kg 6,60

**Birdie 9**  
net kg 9,50

Halo, Fluo, LED retrofit light bulbs not included  
→ specifications p. 182

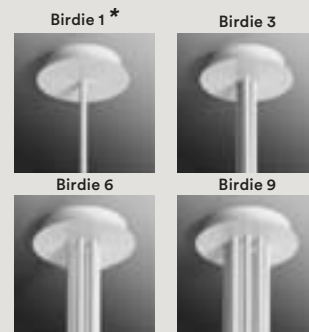
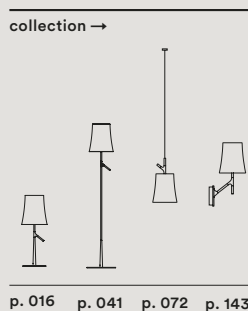
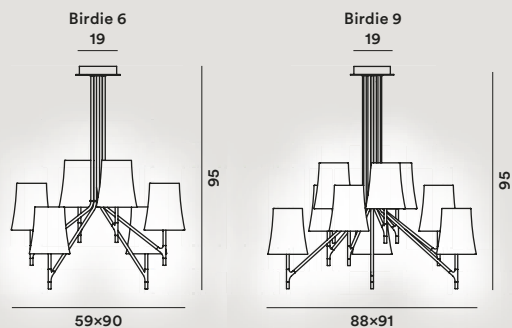
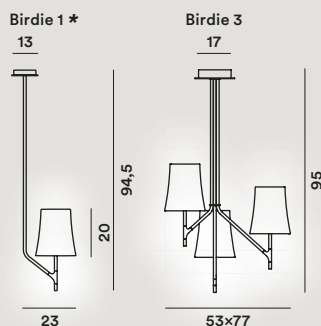

## Birdie

Ludovica + Roberto  
Palomba, 2013



Polycarbonate and coated  
aluminium

LED retrofit or Fluo  
6-9x20W E26  
Halo 6-9x60W E27



	energy cl.	colours	code	vat excluded
<b>Birdie 6 with cables</b>	A <sup>+</sup> , A, B, C	bianco	2210076 10	1.571,00
		grigio	2210076 25	
		arancio	2210076 53	
		amaranto	2210076 65	
<b>Birdie 6 h. 5 m with cables</b>		bianco	2210076SP5 10	1.609,00
		grigio	2210076SP5 25	
		arancio	2210076SP5 53	
		amaranto	2210076SP5 65	
<b>Birdie 9 with cables</b>	A <sup>+</sup> , A, B, C	bianco	2210079 10	2.219,00
		grigio	2210079 25	
		arancio	2210079 53	
		amaranto	2210079 65	
<b>Birdie 9 h. 5 m with cables</b>		bianco	2210079SP5 10	2.257,00
		grigio	2210079SP5 25	
		arancio	2210079SP5 53	
		amaranto	2210079SP5 65	
<b>Spare parts:</b>				
<b>Lampshade Birdie</b>		bianco	221S002 10	46,00
		grigio	221S002 25	
		arancio	221S002 53	
		amaranto	221S002 65	

Colours: bianco, grigio,  
arancio, amaranto



Special colours  
on request

Weight:  
**Birdie 6**  
net kg 6,60

**Birdie 9**  
net kg 9,50

Halo, Fluo, LED retrofit  
light bulbs not included  
→ specifications p. 182

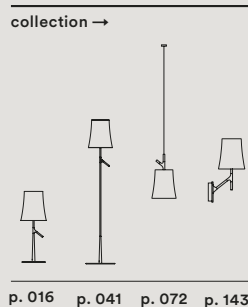
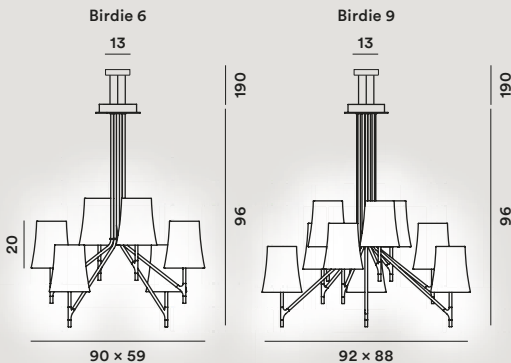

**Blob S**

Karim Rashid, 2002



	energy cl.	colours	code	vat excluded
<i>Blob S</i>	A <sup>+</sup> , A	bianco	124035 10	185,00
<b>Spare parts:</b>				
<i>Lampshade Blob S</i>		bianco	124S00 10	62,00

Rotational moulded polyethylene and coated metal

Fluo 1x24W 2G11

☐ ▽ CE IP 20

Colours: bianco



Weight:  
net kg 1,10

Fluo light bulbs  
not included  
→ specifications p. 182

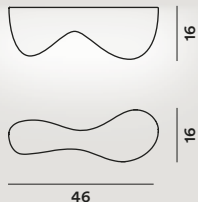

collection →



## Caboche

Patricia Urquiola con  
Elia Gerotto, 2006



PMMA, blown glass and  
chromed metal

LED retrofit or Halo  
1x120W R7s



	energy cl.	colours	code	vat excluded
<i>Caboche</i>	A <sup>+</sup> , A, C	trasparente	138008 16	773,00
		giallo oro	138008 52	
<b>Spare parts:</b>				<b>277,00</b>
<i>Set sphere Caboche</i>		trasparente	138S008 16	
		giallo oro	138S008 52	
<i>Kit 15 prongs 3 sphere Caboche</i>			138KIT 15M3	29,00
<i>Kit 15 prongs 4 sphere Caboche</i>			138KIT 15S4	29,00
<i>Kit 3+3 prongs 3 + 4 sphere Caboche</i>			138KIT3-R2	18,00
<i>Glass Caboche</i>			138V018/1	91,00
<i>Halogen protection glass</i>			PIREX138/2S4I	20,00

Colours: trasparente,  
giallo oro

Weight:  
net kg 9,10

Halo, LED retrofit  
light bulbs not included  
→ specifications p. 182

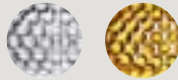

Special colours  
on request

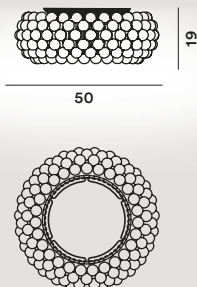

collection →

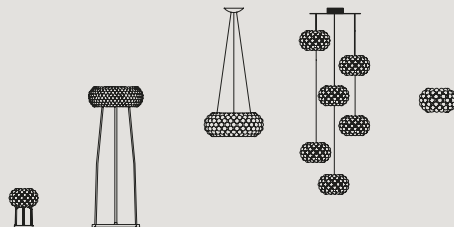

p. 020

p. 042

p. 073/075

p. 112

p. 145



## Circus

Defne Koz, 1994



	energy cl.	colours	code	vat excluded
<i>Circus grande</i>	A <sup>+</sup> , A, B, C	bianco	0460081 11	420,00
<i>Circus piccola</i>	A <sup>+</sup> , A, B, C	bianco	046008 11	267,00

### Spare parts:

<i>Glass Circus grande</i>	bianco	046S001 11	270,00
<i>Glass Circus piccola</i>	bianco	046S00 11	150,00

Blown glass, nickel-plated or coated metal

*Circus grande*  
LED retrofit or Fluo  
4x12W E27  
Halo 4x46W E27

*Circus piccola*  
LED retrofit or Fluo  
4x8W E14  
Halo 4x30W E14



Colours: bianco



Special colours  
on request

Weight:  
*Circus grande*  
net kg 4,70

*Circus piccola*  
net kg 2,10

Halo, Fluo, LED retrofit  
light bulbs not included  
→ specifications p. 182

grande



46

piccola



32

collection →



p. 145



**Ellepi**

Alessandra Matilde, 2003



Methacrylate and coated metal

Fluo 1x55W 2GX13

	energy cl.	colours	code	vat excluded
<i>Ellepi</i>	A <sup>+</sup> , A	bianco	128005 10	399,00
<b>Spare parts:</b>				
<i>Lampshade Ellepi</i>		bianco	128S00 10	206,00

Colours: bianco

Special colours  
on requestWeight:  
net kg 4,30Fluo light bulbs  
not included  
→ specifications p. 182

6,5

collection →

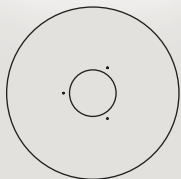

74



p. 149

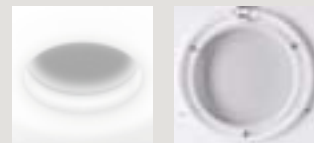

## Falena

Lucidi e Pevere, 2011



	energy cl.	colours	code	vat excluded
<b>Falena 2</b>	A <sup>+</sup> , A	bianco *	215005F2 10	391,00
<b>Falena 3</b>	A <sup>+</sup> , A	bianco *	215005F3 10	515,00
<b>Falena 2 dimmable</b>	A <sup>+</sup> , A	bianco *	215005F2DM 10	476,00
<b>Falena 3 dimmable</b>	A <sup>+</sup> , A	bianco *	215005F3DM 10	601,00

\* Limited stock available

Coated aluminium and polycarbonate

**Falena 2**  
Fluo 1x24W G5

**Falena 3**  
Fluo 1x54W G5  
Dimmable version  
Possible configurations:  
On-Off/Push/DALI



Colours: bianco\*  
\* Limited stock available



Weight:  
**Falena 2**  
net kg 3,00

**Falena 3**  
net kg 5,20

Fluo light bulbs  
not included  
→ specifications p. 182

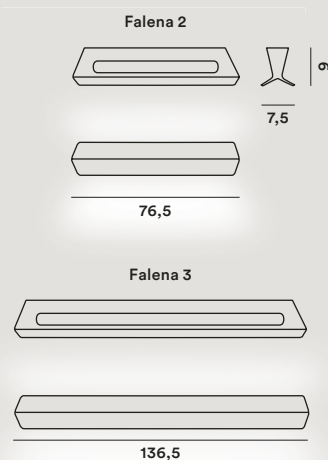

collection →



p. 150

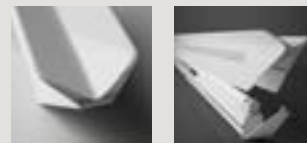



## Folio

Carlo Urbinati e Alessandro Vecchiato, 1990



Blown acid-etched glass and coated metal

LED retrofit or Halo 1x120W R7s

⊕ ⚡ CE IP 20

	energy cl.	colours	code	vat excluded
<i>Folio grande halogen</i>	A <sup>+</sup> , A, C	bianco	019008 10	359,00
<b>Spare parts:</b>				
<i>Glass Folio grande</i>		bianco	019S001 10	211,00
<i>Halogen protection glass</i>			PIREX94/4/I	21,00

Colours: bianco



Special colours on request

Weight:  
net kg 2,20

Halo, LED retrofit  
light bulbs not included  
→ specifications p. 182

collection →



48



p. 153



**Gregg**

Ludovica e Roberto  
Palomba, 2007



	energy cl.	colours	code	vat excluded
<i>Gregg media</i>	A <sup>+</sup> , A, B, C	bianco	168005 10	298,00
<i>Gregg piccola</i>	A <sup>+</sup> , A, C	bianco	1680052 10	145,00
<b>Spare parts:</b>				
<i>Glass Gregg media</i>		bianco	168S00 10	172,00
<i>Glass Gregg piccola</i>		bianco	168S00210	59,00

Blown acid-etched and white lacquered metal

*Gregg media*  
LED retrofit or Fluo  
1x25W E27  
Halo 1x150W E27

*Gregg piccola*  
LED retrofit or Halo  
1x20W G9



Colours: bianco



Special colours  
on request

Weight:  
*Gregg media*  
net kg 2,90

*Gregg piccola*  
net kg 0,90

Halo, Fluo, LED retrofit  
light bulbs not included  
→ specifications p. 182

media

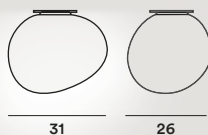

31

26

27

piccola



13

11

collection →

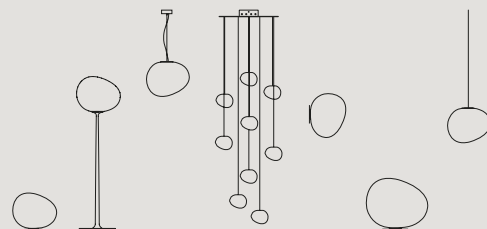

p. 023 p. 045 p. 082 p. 112 p. 154 168 p. 171

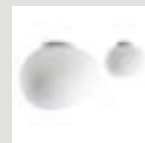

**Lumiere xxl + xxs**

Rodolfo Dordoni, 2010



Blown glass and lacquered metal

**Lumiere xxl**

Fluo 1x40W + 1x22W 2GX13

dimmable 1x55W 2GX13

Dimmable version

Possible configurations:

On-Off/Push/DALI

**Lumiere xxs**

Fluo 2x18W G24q-2



	energy cl.	colours	code	vat excluded
<b>Lumiere xxl</b>	A <sup>+</sup> , A	bianco	191005 11	361,00
<b>Lumiere xxs</b>	A <sup>+</sup> , A	bianco	1910052 11	308,00
<b>Lumiere xxl dimmable</b>	A <sup>+</sup> , A	bianco	191005DM 11	434,00
<b>Spare parts:</b>				
<b>Glass Lumiere xxl</b>		bianco	191S0051 11	203,00
<b>Glass Lumiere xxs</b>		bianco	191S0052 11	146,00

Colours: bianco



Special colours  
on request

Weight:

**Lumiere xxl**

net kg 3,40

**Lumiere xxs**

net kg 1,80

Fluo light bulbs

not included

→ specifications p. 182

**Lumiere xxl****Lumiere xxs**

collection →



p. 028

p. 048

p. 160



## Nuage

Philippe Nigro, 2012



Injection-moulded polycarbonate and batch-dyed ABS

Fluo 1x40W + 1x22W 2GX13  
 dimmable 1x55W 2GX13  
 Dimmable version  
 Possible configurations:  
 On-Off/Push/DALI

Usable in composition



	energy cl.	colours	code	vat excluded
<b>Nuage</b>	A <sup>+</sup> , A	bianco	243005 10	407,00
		rosso	243005 63	
<b>Nuage dimmable</b>	A <sup>+</sup> , A	bianco	243005DM 10	460,00
		rosso	243005DM 63	
<b>Accessories</b>				
<b>Lamp connection kit</b>		40+22W	243KIT	26,00
		dimmable	243KIT DM	40,00
<b>Spare parts:</b>				
<b>Set lampshades Nuage</b>		bianco	243S00 10	281,00
		rosso	243S00 63	

Colours: bianco, rosso



Weight:  
net kg 3,20

Fluo light bulbs  
not included  
→ specifications p. 182

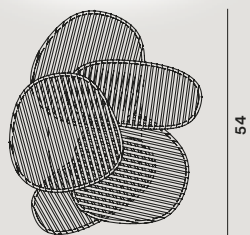
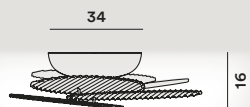

collection →

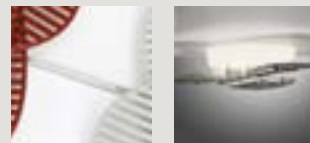
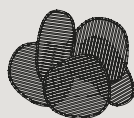

## Rituals

Ludovica e Roberto  
Palomba, 2015



Blown satin glass and  
lacquered metal

LED retrofit or Fluo  
1x20W E27  
Halo 1x70W E27

⊕ ⚡ CE IP 20

	energy cl.	colours	code	vat excluded
<i>Rituals 1</i>	A <sup>+</sup> , A, B, C	bianco	2440081 10	345,00
<i>Rituals 2</i>	A <sup>+</sup> , A, B, C	bianco	2440082 10	345,00
<i>Rituals 3</i>	A <sup>+</sup> , A, B, C	bianco	2440083 10	290,00
<b>Spare parts:</b>				
<i>Glass Rituals 1</i>		bianco	244S001 10	222,00
<i>Glass Rituals 2</i>		bianco	244S002 10	222,00
<i>Glass Rituals 3</i>		bianco	244S003 10	167,00

Colours: bianco



Weight:  
*Rituals 1*  
net kg 4,10

*Rituals 2*  
net kg 4,20

*Rituals 3*  
net kg 1,70

Halo, Fluo, LED retrofit  
light bulbs not included  
→ specifications p. 182

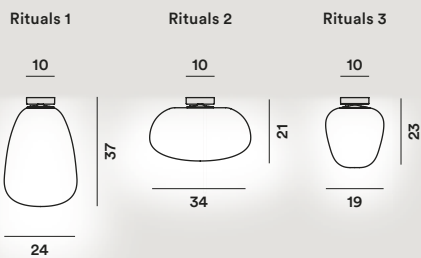

collection →

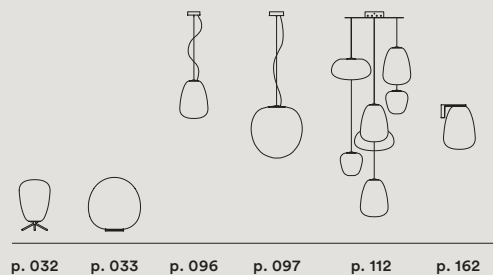

p. 032

p. 033

p. 096

p. 097

p. 112

p. 162

**Tivu**

Joseph Forakis, 2011



	energy cl.	colours	code	vat excluded
<i>Tivu grande</i>	A <sup>+</sup> , A	bianco	207005 10	202,00
		nero	207005 20	

Injection-moulded polycarbonate

Fluo 2x18W 2G11



Colours: bianco, nero



Special colours on request

Weight: net kg 1,30

Fluo light bulbs not included  
→ specifications p. 182

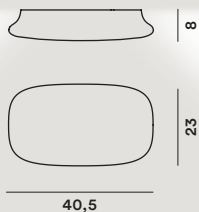

collection →



# Twiggy

Marc Sadler, 2007



	energy cl.	colours	code	vat excluded
<i>Twiggy</i>	A <sup>+</sup> , A, B, C	bianco	159008 10	950,00
		nero	159008 20	

**Spare parts:**

<i>Lampshade Twiggy</i>	bianco	159S10 10	464,00
	nero	159S10 20	
<i>Lower diffusor disk</i>		159R05	33,00

Compound material on lacquered glass fibre base, PMMA and lacquered metal

LED retrofit or Fluo  
3x20W E27  
Halo 3x77W E27

Rotating 330°

Stem lenght cannot be changed



Colours: bianco, nero

Weight:  
net kg 5,60

Halo, Fluo, LED retrofit  
light bulbs not included  
→ specifications p. 182



Special colours  
on request

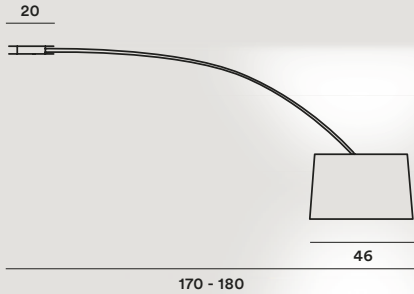

collection →

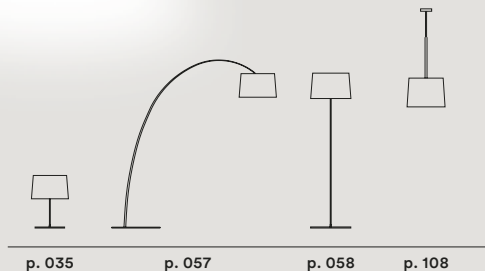
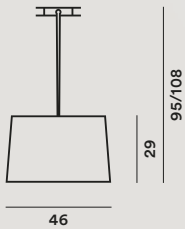





*Parete, Wall*

- |     |                               |     |                              |
|-----|-------------------------------|-----|------------------------------|
| 140 | <b>Aplomb</b>                 | 153 | <b>Folio</b>                 |
| 141 | <b>Bahia +<br/>Bahia mini</b> | 154 | <b>Gregg</b>                 |
| 142 | <b>Big Bang</b>               | 155 | <b>Havana</b>                |
| 143 | <b>Birdie</b>                 | 156 | <b>Innerlight</b>            |
| 144 | <b>Bit</b>                    | 157 | <b>Kite</b>                  |
| 145 | <b>Blob S</b>                 | 157 | <b>Lake</b>                  |
| 146 | <b>Caboche</b>                | 159 | <b>Le Soleil</b>             |
| 147 | <b>Circus</b>                 | 160 | <b>Lumiere<br/>xxl + xxs</b> |
| 148 | <b>Double</b>                 | 161 | <b>Nuage</b>                 |
| 149 | <b>Ellepi</b>                 | 162 | <b>Rituals</b>               |
| 150 | <b>Falena</b>                 | 163 | <b>Tivu</b>                  |
| 151 | <b>Fields</b>                 | 164 | <b>Tress</b>                 |
| 152 | <b>Flip</b>                   | 165 | <b>Tutù</b>                  |

## Aplomb

Lucidi e Pevere, 2014



	energy cl.	colours	code	vat excluded
<i>Aplomb</i>	A <sup>+</sup>	bianco	195005L 10	416,00
		grigio	195005L 25	
		marrone	195005L 52	

Concrete, varnished metal and aluminium

LED included  
13W Acrich 2700°K 1120 lm  
CRI > 80 86 lm/W  
Dimmable only with Seoul-Acrich LED compatible modules



Colours: bianco, grigio cemento, marrone

Weight: net kg 2,00



Tecnico — 2017

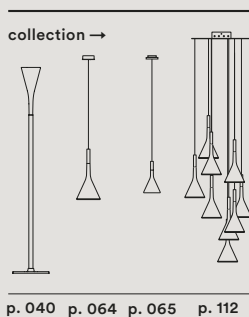
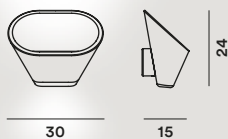

**Bahia + Bahia mini**

Lucidi e Pevere, 2010-2015

LED



Injection moulded  
polycarbonate

*Bahia fluo*  
Fluo 1x40W + 1x22W 2GX13

*Bahia LED* included  
43W Mid-power 2850° K  
4210 lm CRI>90 97,9 lm/W  
Dimmable version Possible  
configurations:  
On-Off/Push/DALI"

*Bahia mini fluo*  
Fluo 1x22W 2GX13  
Dimmable version Possible  
configurations:  
On-Off/Push/DALI

*Bahia mini LED* included  
21W Mid- power 2850° K  
2425 lm CRI>90 115 lm/W  
Dimmable version Possible  
configurations  
On-Off/Push/DALI



Colours: bianco



Weight:  
*Bahia*  
net kg 3,40

*Bahia mini*  
net kg 2,00

Fluo light bulbs  
not included  
→ specifications p. 182

	energy cl.	colours	code	vat excluded
<i>Bahia fluo</i>	A <sup>+</sup> , A	bianco	196005 10	445,00
<i>Bahia LED</i>	A <sup>+</sup>	bianco	196005L 10	622,00
<i>Bahia LED dimmable</i>	A <sup>+</sup>	bianco	196005LD 10	671,00
<i>Bahia mini fluo</i>	A <sup>+</sup> , A	bianco	1960052 10	248,00
<i>Bahia mini fluo dimmable</i>	A <sup>+</sup> , A	bianco	1960052D 10	311,00
<i>Bahia mini LED</i>	A <sup>+</sup>	bianco	1960052L 10	399,00
<i>Bahia mini LED dimmable</i>	A <sup>+</sup>	bianco	1960052LD 10	450,00

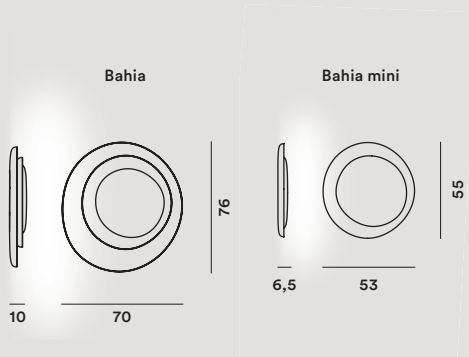

collection →



p. 122

p. 122

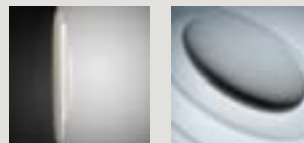

## Big Bang

Enrico Franzolini con Vicente Garcia Jimenez, 2005



	energy cl.	colours	code	vat excluded
<i>Big Bang</i>	A <sup>+</sup> , A, C	bianco	151005 10	429,00
		rosso	151005 63	445,00
<b>Spare parts:</b>				
<i>Set lampshades Big Bang</i>		bianco	151S05 10	254,00
		rosso	151S05 63	270,00
<i>Halogen protection glass</i>			PIREX94/4/I	21,00

Methacrylate and lacquered metal

LED retrofit or Halo  
1x120W R7s

⊕ ⚡ CE IP 20

Colours: bianco, rosso



Special colours  
on request

Weight:  
net kg 3,00

Halo, LED retrofit  
light bulbs not included  
→ specifications p. 182

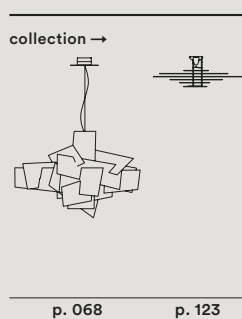
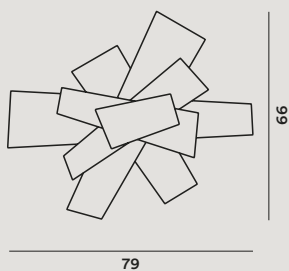

## Birdie

Ludovica + Roberto  
Palomba, 2012



Polycarbonate, coated steel  
and metal

**Birdie**  
LED retrofit or Fluo  
1x25W E27  
Halo 1x70W E27

⊕ ⊖ CE IP 20

**Birdie with Integrated touch  
dimmer**  
Dimmerable LED retrofit or  
Halo 1x70W E27  
minimum Halo bulb output  
40W

⊕ ⊖ CE IP 20

	energy cl.	colours	code	vat excluded
<b>Birdie</b>	A <sup>+</sup> , A, B, C	bianco	2210052 10	215,00
		grigio	2210052 25	
		arancio	2210052 53	
		amaranto	2210052 65	
<b>Birdie with touch dimmer</b>	A <sup>+</sup> , A, C	bianco	2210052DM 10	267,00
		grigio	2210052DM 25	
		arancio	2210052DM 53	
		amaranto	2210052DM 65	
<b>Spare parts:</b>				
<b>Lampshade Birdie</b>		bianco	221S002 10	46,00
		grigio	221S002 25	
		arancio	221S002 53	
		amaranto	221S002 65	

Colours: bianco, grigio,  
arancio, amaranto

Weight:  
net kg 1,60

Halo, Fluo, LED retrofit  
light bulbs not included  
→ specifications p. 182



Special colours  
on request

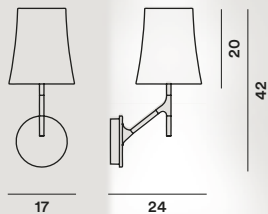

collection →

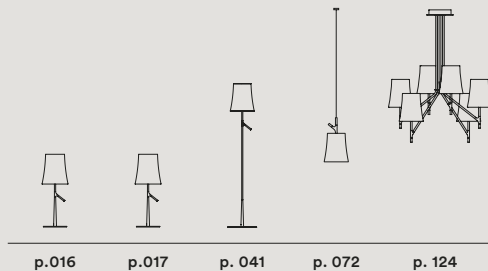

p.016

p.017

p. 041

p. 072

p. 124

**Bit**

Ferruccio Laviani, 1993



Silkscreen-printed glass and lacquered metal

LED retrofit or Fluo  
1x12W E14  
Halo 1x46W E14



	energy cl.	colours	code	vat excluded
<b>Bit 1</b>	A <sup>+</sup> , A, C	rosso	0430051	196,00
		bianco	0430051 10	
<b>Bit 2</b>	A <sup>+</sup> , A, C	blu	0430052	196,00
		bianco	0430052 10	
<b>Bit 3</b>	A <sup>+</sup> , A, C	bianco	0430053	196,00
<b>Bit 4</b>	A <sup>+</sup> , A, C	verde	0430054	196,00
		bianco	0430054 10	
<b>Bit 5</b>	A <sup>+</sup> , A, C	arancio	0430055	196,00
		bianco	0430055 10	

**Spare parts:**

<b>Glass Bit 1</b>	bianco	043S00/1 10	50,00
	rosso	043S00/1 63	
<b>Glass Bit 2</b>	bianco	043S00/2 10	50,00
	blu	043S00/2 33	
<b>Glass Bit 3</b>	bianco	043S00/3 10	50,00
<b>Glass Bit 4</b>	bianco	043S00/4 10	50,00
	verde	043S00/4 40	
<b>Glass Bit 5</b>	bianco	043S00/5 10	50,00
	arancio	043S00/5 52	

Colours: bianco, colorato  
(1 rosso, 2 blu, 4 verde,  
5 arancio)



**Weight:**

**Bit 1**  
net kg 1,70  
**Bit 2**  
net kg 1,20  
**Bit 3**  
net kg 1,80  
**Bit 4**  
net kg 1,25  
**Bit 5**  
net kg 1,35

Halo, Fluo, LED retrofit  
light bulbs not included  
→ specifications p. 182

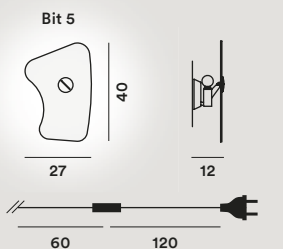
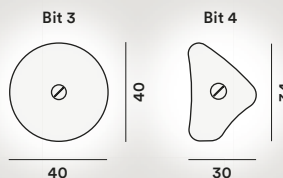
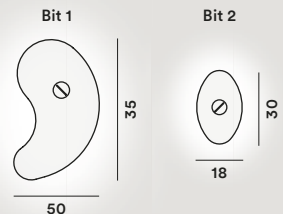

collection →



p. 051



**Blob S**

Karim Rashid, 2002



Rotational moulded  
polyethylene

Fluo 1x24W 2G11

☐ ▽ CE IP 20

	energy cl.	colours	code	vat excluded
<i>Blob S</i>	A <sup>+</sup> , A	bianco	124035 10	185,00
<b>Spare parts:</b>				
<i>Lampshade Blob S</i>	A <sup>+</sup> , A	bianco	124S00 10	62,00

Colours: bianco



Weight:  
net kg 1,10

Fluo light bulbs  
not included  
→ specifications p. 182

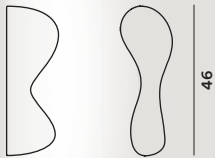

16

16

46

collection →



p. 126



## Caboche

Patricia Urquiola  
con Eliana Gerotto, 2006



PMMA, blown glass and  
chromed metal

LED retrofit or Halo  
1x120W R7s



	energy cl.	colours	code	vat excluded
<i>Caboche media</i>	A <sup>+</sup> , A, C	trasparente	138005 16	584,00
		giallo oro	138005 52	
<i>Caboche piccola</i>	A <sup>+</sup> , A, C	trasparente	138025 16	303,00
		giallo oro	138025 52	

### Spare parts:

<i>Set sphere Caboche media</i>	trasparente	138S05 16	241,00
	giallo oro	138S05 52	
<i>Kit 15 prongs 3 sphere Caboche media</i>		138KIT 15M3	29,00
<i>Kit 15 prongs 4 sphere Caboche media</i>		138KIT 15M4	29,00
<i>Kit 3+3 prongs, 3-4 sphere Caboche media</i>		138KIT-R2	21,00
<i>Set sphere Caboche piccola</i>	trasparente	138S005 16	95,00
	giallo oro	138S005 52	
<i>Kit 10 prongs, 3 sphere Caboche piccola</i>		138KIT 10P3	24,00
<i>Kit 10 prongs 4 sphere Caboche piccola</i>		138KIT 10P4	24,00
<i>Kit 3+3 prongs 3-4 sphere Caboche piccola</i>		138KIT2-R2	18,00
<i>Glass Caboche</i>		138V052/1	64,00
<i>Halogen protection glass</i>		PIREX94/4/1	21,00

Colours: trasparente,  
giallo oro

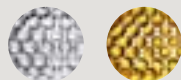

Special colours  
on request

Weight:  
*Caboche media*  
net kg 4,50

*Caboche piccola*  
net kg 2,60

Halo, LED retrofit  
light bulbs not included  
→ specifications p. 182

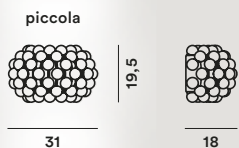
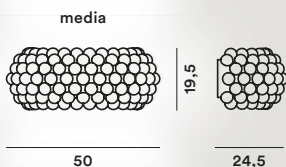

collection →

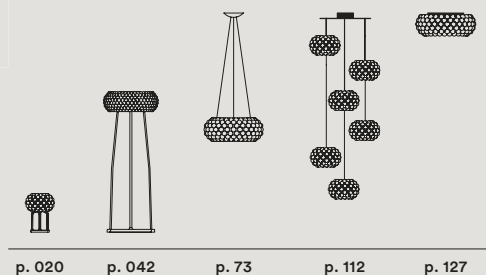



# Circus

Defne Koz, 1994



	energy cl.	colours	code	vat excluded
<i>Circus grande</i>	A <sup>+</sup> , A, B, C	bianco	0460081 11	420,00
<i>Circus piccola</i>	A <sup>+</sup> , A, B, C	bianco	046008 11	267,00

**Spare parts:**

<i>Glass Circus grande</i>	bianco	046S001 11	270,00
<i>Glass Circus piccola</i>	bianco	046S00 11	150,00

Blown glass, nickel-plated or coated metal

*Circus grande*  
LED retrofit or Fluo  
4x12W E27  
Halo 4x46W E27

*Circus piccola*  
LED retrofit or Fluo  
4x8W E14  
Halo 4x30W E14



Colours: bianco



Special colours  
on request

Weight:  
*Circus grande*  
net kg 4,70

*Circus piccola*  
net kg 2,10

Halo, Fluo, LED retrofit  
light bulbs not included  
→ specifications p. 182

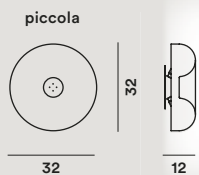
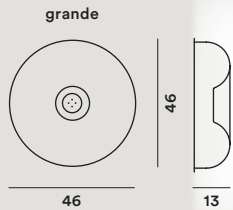

collection →



p. 128

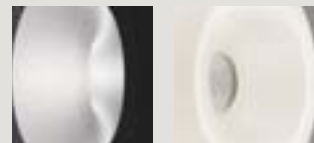

**Double**

Valerio Bottin, 1996



	energy cl.	colours	code	vat excluded
<i>Double</i>	A <sup>+</sup> , A, B, C	bianco	069005 11	269,00
		avorio	069005 51	
<b>Spare parts:</b>				
<i>Glass Double</i>		bianco	069S00 11	158,00
		avorio	069S00 51	

Blown glass and coated metal

LED retrofit or Fluo  
2x20W E27  
Halo 2x77W E27



IP 20

Colours: bianco, avorio



Special colours  
on request

Weight:  
netto kg 2,00

Halo, Fluo, LED retrofit  
light bulbs not included  
→ specifications p. 182

Tecnico — 2017



26

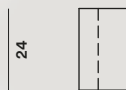

13

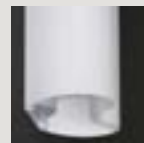

**Ellepi**

Alessandra Matilde, 2003



Methacrylate and coated  
metal

Fluo 1x55W 2GX13

⊕ ⚡ CE IP 20

	energy cl.	colours	code	vat excluded
<i>Ellepi</i>	A <sup>+</sup> , A	bianco	128005 10	399,00
<b>Spare parts:</b>				
<i>Lampshade Ellepi</i>		bianco	128S00 10	206,00

Weight: bianco



Special colours  
on request

Peso:  
netto kg 4,30

Fluo light bulbs  
not included  
→ specifications p. 182

collection →

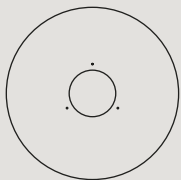

74

6,5

p. 129

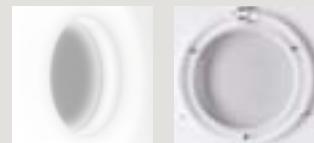

## Falena

Lucidi e Pevere, 2011



	energy cl.	colours	code	vat excluded
<b>Falena 1</b>	A <sup>+</sup> , A, C	bianco *	215005 10	206,00
<b>Falena 2</b>	A <sup>+</sup> , A	bianco *	215005F2 10	391,00
<b>Falena 3</b>	A <sup>+</sup> , A	bianco *	215005F3 10	515,00
<b>Falena 2 dimmable</b>	A <sup>+</sup> , A	bianco *	215005F2DM 10	476,00
<b>Falena 3 dimmable</b>	A <sup>+</sup> , A	bianco *	215005F3DM 10	601,00

### Spare parts:

<b>Halogen protection glass</b>	PIREX94/4/1	21,00
---------------------------------	-------------	-------

\* Limited stock available

Coated aluminium and polycarbonate

**Falena 1**  
LED retrofit or Halo  
1x80W R7s

**Falena 2**  
Fluo 1x24W G5

**Falena 3**  
Fluo 1x54W G5

**Falena 2-3**  
Horizontal and vertical use

Dimmable version possible  
configurations:  
On-Off/Push/DALI



Colours: bianco  
\* Limited stock available



Weight:  
**Falena 1**  
net kg 0,80

**Falena 2**  
net kg 3,00

**Falena 3**  
net kg 5,20

Halo, Fluo, LED retrofit  
light bulbs not included  
→ specifications p. 182

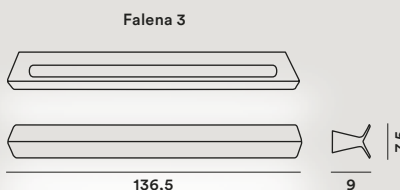
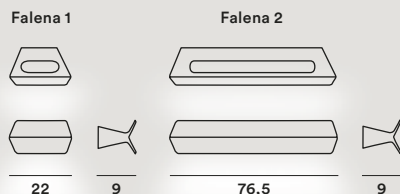

collection →

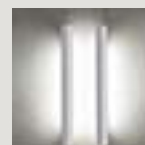

**Fields**

Vicente Garcia Jimenez,  
2007



Methacrylate, coated  
aluminium and  
polycarbonate

*Fields 1*  
Fluo 1x80W G5

*Fields 2*  
Fluo 1x54W G5

*Fields 3*  
Fluo 1x39W G5

Horizontal and vertical use

*Fields*  
Fluo 1x80W G5 + 1x54W G5  
+ 1x39W G5



	energy cl.	colours	code	vat excluded
<i>Fields</i>	A <sup>+</sup> , A	bianco	174005 10	1.843,00
		arancio	174005 63	
<i>Fields 1</i>	A <sup>+</sup> , A	bianco	1740051 10	571,00
		arancio	1740051 63	
<i>Fields 2</i>	A <sup>+</sup> , A	bianco	1740052 10	671,00
		arancio	1740052 63	
<i>Fields 3</i>	A <sup>+</sup> , A	bianco	1740053 10	601,00
		arancio	1740053 63	
<b>Spare parts:</b>				
<i>Set lampshades Fields 2</i>		bianco	174S002 10	87,00
		arancio	174S002 63	
<i>Set lampshades Fields 3</i>		bianco	174S003 10	85,00
		arancio	174S003 63	

Colours:  
bianco, arancio



Special colours  
on request

Weight:  
*Fields 1*  
net kg 6,00

*Fields 2*  
net kg 6,50

*Fields 3*  
net kg 5,80

*Fields*  
net kg 18,30

Fluo light bulbs  
not included  
→ specifications p. 182

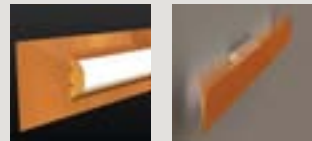
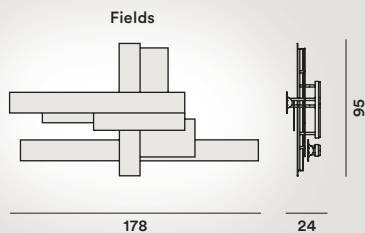
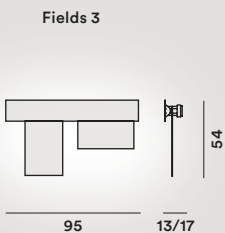
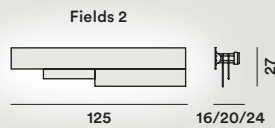
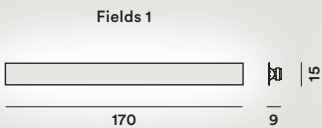

**Flip**

Simon Pengelly, 2013



	energy cl.	colours	code	vat excluded
<i>Flip halogen</i>	A <sup>+</sup> , A, C	bianco *	251005 10	242,00
<i>Flip LED</i>	A	bianco *	251005L 10	382,00

**Spare parts:**

<i>Lampshade Flip</i>		251S00 10	81,00
<i>Halogen protection glass</i>		PIREX94/4/1	21,00

\* Limited stock available

Injection moulded coated polycarbonate and coated metal or aluminium (LED)

Colours: bianco\*  
Limited stock available

Weight:  
net kg 1,20

Halo, LED retrofit light bulbs not included  
→ specifications p. 182

*Flip halogen*  
LED retrofit or Halo  
1x120W R7s



*Flip LED*  
LED included  
16W 2700°K  
1200 lm CRI > 80 75 lm/W

Dimmable only with Seoul-Acrich LED compatible modules



Tecnico — 2017

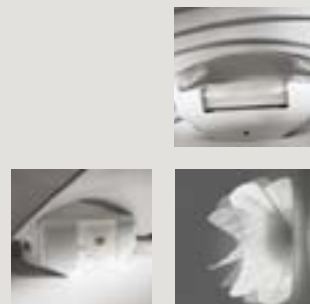
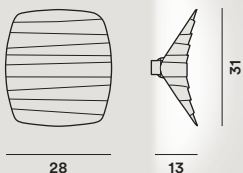

**Folio**

Carlo Urbinati e Alessandro Vecchiato, 1990



	energy cl.	colours	code	vat excluded
<i>Folio grande halogen</i>	A <sup>+</sup> , A, C	bianco	0190051 10	336,00
<i>Folio piccola halogen</i>	A <sup>+</sup> , A, C	bianco	019005-R1 10	252,00

**Spare parts:**

<i>Glass Folio grande</i>	bianco	019S001 10	211,00
<i>Glass Folio piccola</i>	bianco	019S00 10	131,00
<i>Halogen protection glass</i>	bianco	PIREX94/4/I	21,00

Blown acid-etched glass and coated metal

LED retrofit or Halo 1x120W R7s



Colours: bianco



Special colours on request

Weight:  
*Folio grande*  
net kg 2,17

*Folio piccola*  
net kg 1,48

Halo, LED retrofit light bulbs not included  
→ specifications p. 182

grande

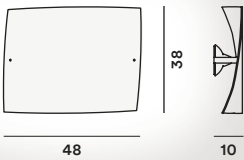

collection →



piccola

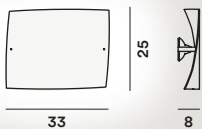

**Gregg**

Ludovica + Roberto  
Palomba, 2007

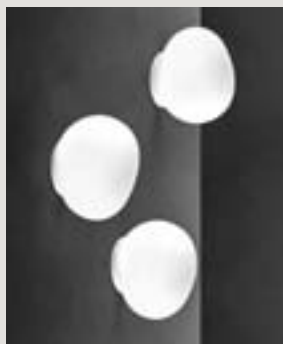

	energy cl.	colours	code	vat excluded
<i>Gregg media</i>	A <sup>+</sup> , A, C	bianco	168005 10	298,00
<i>Gregg piccola</i>	A <sup>+</sup> , A, C	bianco	1680052 10	145,00

**Spare parts:**

<i>Glass Gregg media</i>	bianco	168S00 10	172,00
<i>Glass Gregg piccola</i>	bianco	168S00210	59,00

Blown acid-etched glass and coated metal

*Gregg media*  
LED retrofit or Fluo  
1x25W E27  
Halo 1x150W E27

*Gregg piccola*  
LED retrofit or Halo  
1x20W G9



Colours: bianco



Special colours  
on request

Weight:  
*Gregg media*  
net kg 2,90

*Gregg piccola*  
net kg 0,60

Halo, Fluo, LED retrofit  
light bulbs not included  
→ specifications p. 182

media

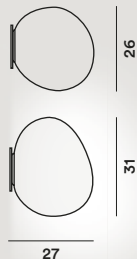

piccola

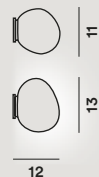

collection →

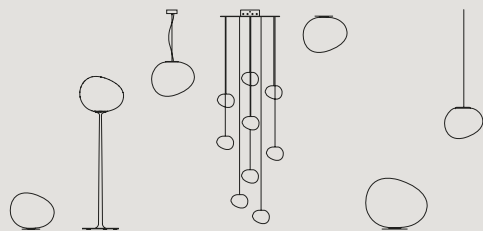

p. 023 p. 045 p. 082 p. 112 p. 132 p. 168 p. 173



# Havana

Joseph Forakis, 1993



Injection moulded polyethylene and coated metal

LED retrofit or Fluo  
1x25W E27  
Halo 1x116W E27



	energy cl.	colours	code	vat excluded
<i>Havana</i>	A+, A, B, C	bianco	0400072-R1 10	200,00
<b>Spare parts:</b>				
<i>Set lampshades Havana</i>		bianco	040S00 10	79,00

Colours: bianco



Special colours on request

Weight:  
net kg 1,90

Halo, Fluo, LED retrofit light bulbs not included  
→ specifications p. 182

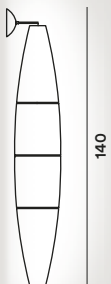

27

collection →

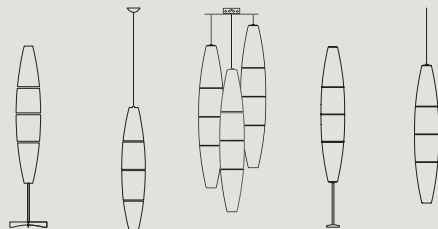

p. 046

p. 085

p. 112

p. 169

p. 172

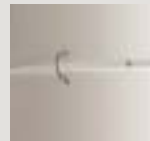

## Innerlight

Simon Pengelly, 2012



	energy cl.	colours	code	vat excluded
<b>Innerlight</b>	A <sup>+</sup> , A	bianco	233005 10	412,00
		marrone *	233005 52	542,00
<b>Innerlight dimmable</b>	A <sup>+</sup> , A	bianco	233005DM 10	476,00
		marrone *	233005DM 52	606,00

\* Limited stock available

Translucent polycarbonate and coated or acid-etched steel

Fluo 2x36W 2G11

Dimmable version possible configurations:  
On-Off/Push/DALI



Colours: bianco,



marrone\*

Limited stock available



Weight:  
net kg 5,00

Fluo light bulbs  
not included  
→ specifications p. 182



77



11

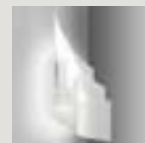

**Kite**

Marc Sadler, 2003



Fiberglass fabric with carbonium thread

LED retrofit or Fluo  
3x12W E14  
Halo 3x30W E14

⊕ ⊖ CE IP 20

	energy cl.	colours	code	vat excluded
<i>Kite</i>	A <sup>+</sup> , A, B, C	nero	1110051 20	269,00
<b>Spare parts:</b>				
<i>Lampshade Kite</i>		nero	111S005 20	199,00

Colours: nero



Weight:  
net kg 0,50

Halo, Fluo, LED retrofit  
light bulbs not included  
→ specifications p. 182

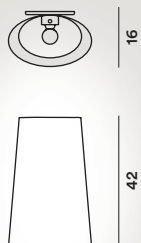

27

collection →

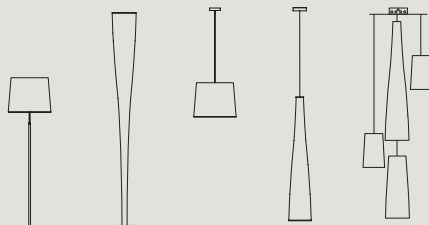

p. 044

p. 050

p. 084

p. 100

p. 112



**Lake**

Lucidi e Pevere, 2015



	energy cl.	colours	code	vat excluded
<i>Lake</i>	A	avorio	257005 50	416,00
		rosso	257005 63	

Injection moulded ABS.

LED included  
12,7W Acrich 3000° K 850 lm  
CRI>80 67 lm/W

Dimmable only with Seoul-  
Acrich LED compatible  
modules

☐ ▽ CE ◀ IP 20

Colours: avorio, rosso



Weight:  
net kg 5,50

Tecnico — 2017

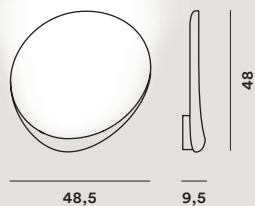

## Le Soleil

Vicente Garcia Jimenez,  
2013



	energy cl.	colours	code	vat excluded
<b>Le soleil</b>	A <sup>+</sup> , A	bianco	181005 10	279,00
		rosso	181005 63	
		acquamarina*	181005 34	
<b>Le soleil dimmable</b>	A <sup>+</sup> , A	bianco	181005DM 10	349,00
		rosso	181005DM 63	
		acquamarina*	181005DM 34	
<b>Spare parts:</b>				
<b>Set lampshades Le soleil</b>		bianco	181S005 10	112,00
		rosso	181S005 63	
		acquamarina*	181S005 34	

\* Limited stock available

Injection moulded varnished polycarbonate and coated metal

Fluo 2x26W G24-q3

Dimmable version possible configurations:  
On-Off/Push/DALI

⊕ ⚡ CE IP 20

Colours: bianco, rosso,



Weight:  
net kg 1,60

Fluo light bulbs  
not included  
→ specifications p. 182

acquamarina\*

Limited stock available



collection →

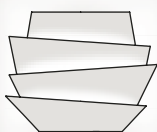

37



14

29



p. 087



**Lumiere xxl + xxs**

Rodolfo Dordoni, 2010



	energy cl.	colours	code	vat excluded
<i>Lumiere xxl</i>	A <sup>+</sup> , A	bianco	191005 11	361,00
<i>Lumiere xxs</i>	A <sup>+</sup> , A	bianco	1910052 11	308,00
<i>Lumiere xxl dimmable</i>	A <sup>+</sup> , A	bianco	191005DM 11	434,00
<b>Spare parts:</b>				
<i>Glass Lumiere xxl</i>		bianco	191S0051 11	203,00
<i>Glass Lumier xxs</i>		bianco	191S0052 11	146,00

Blown glass and lacquered metal

*Lumiere xxl*

Fluo 1x40W + 1x22W 2GX13  
Dimmable 1x55W 2GX13  
Dimmable version possible configurations:  
On-Off/Push/DALI

*Lumiere xxs*

Fluo 2x18W G24q-2



Colours: bianco



Special colours on request

Weight:  
*Lumiere xxl*  
net kg 3,40

*Lumiere xxs*  
net kg 1,80

Fluo light bulbs not included  
→ specifications p. 182

Lumiere xxl

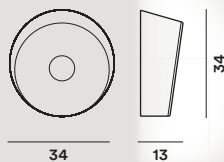

Lumiere xxs

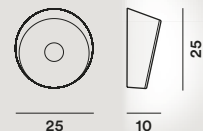

collection →



p. 028 p. 048 p. 160

## Nuage

Philippe Nigro, 2012



	energy cl.	colours	code	vat excluded
<b>Nuage</b>	A <sup>+</sup> , A	bianco	243005 10	407,00
		rosso	243005 63	
<b>Nuage dimmable</b>	A <sup>+</sup> , A	bianco	243005DM 10	460,00
		rosso	243005DM 63	
<b>Accessories</b>				
<b>Lamp connection set</b>		40+22W	243KIT	26,00
		dimmable	243KIT DM	40,00
<b>Spare parts:</b>				
<b>Set lampshades Nuage</b>		bianco	243S00 10	281,00
		rosso	243S00 63	

Injection-moulded polycarbonate and batch-dyed ABS

Fluo 1x40W + 1x22W 2GX13  
Dimmable 1x55W 2GX13

Dimmable version  
Possible configurations:  
On-Off/Push/DALI

Usable in composition



Colours: bianco, rosso

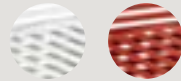

Weight:  
net kg 3,20

Fluo light bulbs  
not included  
→ specifications p. 182

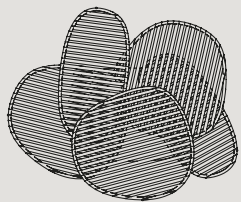

63

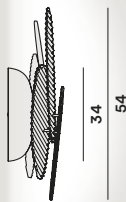

16

collection →



p. 134

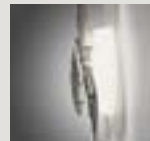

## Rituals

Ludovica + Roberto  
Palomba, 2015



	energy cl.	colours	code	vat excluded
<i>Rituals 1</i>	A <sup>+</sup> , A, B, C	bianco	2440051 10	375,00
<i>Rituals 3</i>	A <sup>+</sup> , A, B, C	bianco	2440053 10	327,00
<i>Rituals 1 doppia</i> on request	A <sup>+</sup> , A, B, C	bianco	24400512 10	693,00
<i>Rituals 3 doppia</i> on request	A <sup>+</sup> , A, B, C	bianco	24400532 10	601,00
<b>Spare parts:</b>				
<i>Glass Rituals 1</i>		bianco	244S001 10	222,00
<i>Glass Rituals 3</i>		bianco	244S003 10	167,00

Blown satin glass and  
lacquered metal

*Rituals 1-3*  
LED retrofit or Fluo  
1x15W E27  
Halo 1x70W E27

*Rituals 1-3 doppia*  
LED retrofit or Fluo  
2x15W E27  
Halo 2x70W E27



Colours: bianco



Weight:  
*Rituals 1*  
net kg 4,80

*Rituals 3*  
net kg 2,40

*Rituals 1 doppia*  
net kg 8,80

*Rituals 3 doppia*  
net kg 6,00

Halo, Fluo, LED retrofit  
light bulbs not included  
→ specifications p. 182

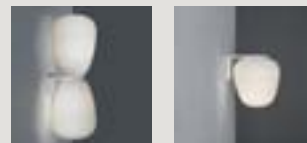
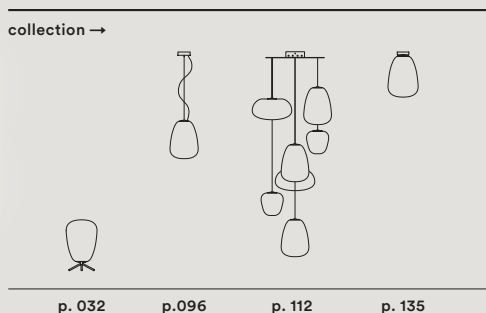
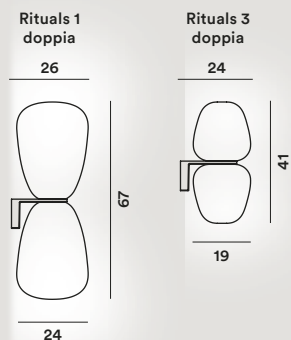
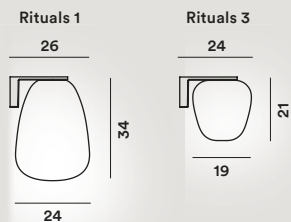



**Tivu**

Joseph Forakis, 2011

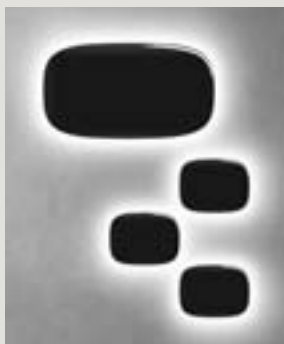

	energy cl.	colours	code	vat excluded
<i>Tivu grande</i>	A <sup>+</sup> , A	bianco	207005 10	202,00
		nero	207005 20	
<i>Tivu piccola</i>	A <sup>+</sup> , A, C	bianco	2070052 10	112,00
		nero	2070052 20	

Injection moulded polycarbonate

*Tivu grande*  
Fluo 2x18W 2G11  
Horizontal and vertical use



*Tivu piccola*  
LED retrofit or Halo  
1x20W G9



Colours: bianco, nero



Weight:  
*Tivu grande*  
net kg 1,30

*Tivu piccola*  
net kg 0,30

Halo, Fluo, LED retrofit  
light bulbs not included  
→ specifications p. 182

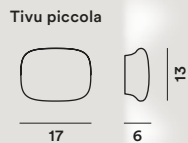
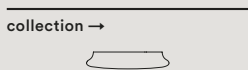
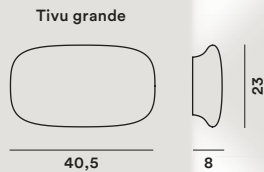

**Tress**

Marc Sadler, 2011



	energy cl.	colours	code	vat excluded
<i>Tress grande</i>	A <sup>+</sup> , A, C	bianco	182005 10	395,00
		nero	182005 20	
<i>Tress piccola</i>	A <sup>+</sup> , A, C	bianco	1820052 10	357,00
		nero	1820052 20	
<b>Spare parts:</b>				
<i>Lampshade Tress grande</i>		bianco	182S005 10	255,00
		nero	182S005 20	
<i>Lampshade Tress piccola</i>		bianco	182S0052 10	217,00
		nero	182S0052 20	
<i>Halogen protection glass</i>			PIREX94/4/1	21,00

Coated fibreglass-based composite material and coated metal

LED retrofit or Halo  
1x120W R7s



Colours: bianco, nero

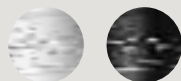

Special colours  
on request

Weight:  
*Tress grande*  
net kg 1,10

*Tress piccola*  
net kg 1,00

Halo, LED retrofit  
light bulbs not included  
→ specifications p. 182

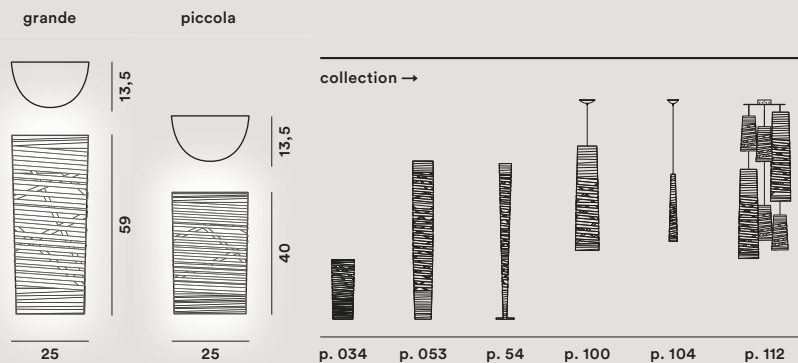

**Tutù**

Valerio Bottin, 2001



	energy cl.	colours	code	vat excluded
<i>Tutù</i>	A <sup>+</sup> , A, B, C	bianco	114005I 11	185,00
		avorio	114005I 51	

**Spare parts:**

<i>Glass Tutù</i>	bianco	114S005 11	87,00
	avorio	114S005 51	

Blown glass, metal and aluminium

LED retrofit or Fluo

2x12W E14

Halo 2x46W E14

⊕ ⚡ CE IP 20

Colours: bianco, avorio



Special colours  
on request

Weight:  
net kg 0,80

Halo, Fluo, LED retrofit  
light bulbs not included  
→ specifications p. 182

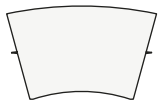

29



13

18





Esterno, *Outdoor*168 **Gregg***outdoor terra*169 **Havana***outdoor terra*170 **Solar** *outdoor*171 **Gregg***outdoor sospensione*172 **Havana***outdoor sospensione*173 **Uto**

**Gregg outdoor**

terra

Ludovica + Roberto Palomba,  
2011



	energy cl.	colours	code	vat excluded
<i>Gregg outdoor X-large</i>	A <sup>+</sup> , A	bianco	218003 10	328,00
<i>Gregg outdoor grande</i>	A <sup>+</sup> , A	bianco	218013 10	250,00
<i>Gregg outdoor media</i>	A <sup>+</sup> , A	bianco	218023 10	192,00
<b>Spare parts:</b>				
<i>Lampshade Gregg outdoor X-large</i>		bianco	218S001 10	179,00
<i>Lampshade Gregg outdoor grande</i>		bianco	218S00 10	101,00
<i>Lampshade Gregg outdoor media</i>		bianco	218S002 10	63,00

Rotational moulded polyethylene and coated metal

*X-large / grande*  
LED retrofit or Fluo  
1x25W E27

*media*  
LED retrofit or Fluo  
1x15W E27

IP 65 - IP 44

Colours: bianco



Weight:  
*X-large*  
net kg 4,30

*grande*  
net kg 3,60

*media*  
net kg 1,60

Fluo, LED retrofit  
light bulbs not included  
→ specifications p. 182

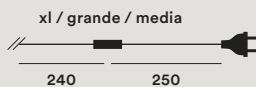
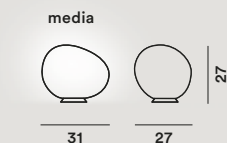
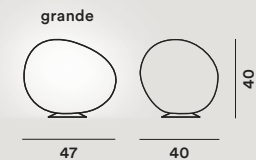
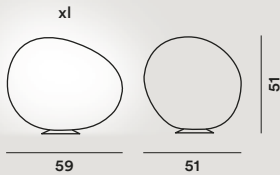

collection →

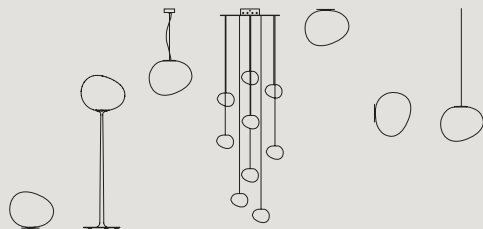

p. 023 p. 045 p. 082 p. 112 p. 132 p. 154 p. 171



## Havana outdoor

terra

Jozeph Forakis, 2005



Rotational moulded polyethylene and coated metal

LED retrofit or Fluo  
1x15W E27  
Halo 1x46W E27

IP 65 - IP 44

	energy cl.	colours	code	vat excluded
<i>Havana out. terra undergr. base</i>	A+, A, B, C	bianco	150003 10	651,00
<i>Havana out. terra stake mounted</i>	A+, A, B, C	bianco	1500031 10	546,00
<i>Havana out. terra base</i>	A+, A, B, C	bianco	1500032 10	584,00
<i>Havana out. terra bassa undergr. base</i>	A+, A, B, C	bianco	150004 10	634,00
<i>Havana out. terra bassa stake mounted</i>	A+, A, B, C	bianco	1500041 10	529,00
<i>Havana out. terra bassa base</i>	A+, A, B, C	bianco	1500042 10	567,00

Spare parts:

<i>Lampshade Havana outdoor</i>	bianco	150S00 10	155,00
<i>Underground base</i>		150S032	120,00
<i>Stake mounted</i>		150S031	109,00
<i>Base</i>		150S033-R1	147,00

Colours: bianco



Special colours on request

Weight:  
*Underground base*  
net kg 5,50

*Stake mounted*  
net kg 5,20

*Base*  
net kg 10,10

Halo, Fluo, LED retrofit light bulbs not included  
→ specifications p. 182

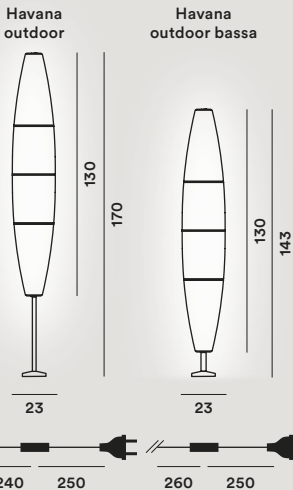
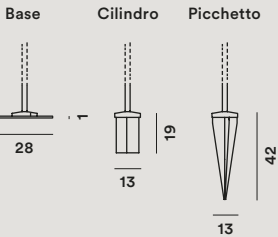

collection →

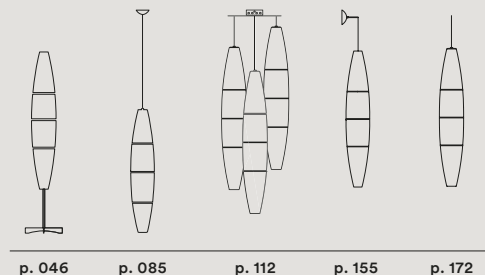

IP 44



IP 65



base



cilindro

picchetto



## Solar

Jean Marie Massaud, 2011



	energy cl.	colours	code	vat excluded
<i>Solar</i>	A <sup>+</sup> , A	marrone	228003M	748,00
<b>Spare parts:</b>				
<i>Lampshade Solar</i>		bianco	228S1110	229,00
<i>Top disk Solar</i>		marrone	228S101M	345,00

Rotational moulded polyethylene, porcelain stoneware top shelf

LED retrofit or Fluo  
1x25W E27

Reclinable up to 15°

☐ ▽ CE ◀ IP 65 IP 44

Colours: marrone



Weight:  
net kg 11,70

Fluo, LED retrofit light bulbs not included  
→ specifications p. 182

Tecnico — 2017

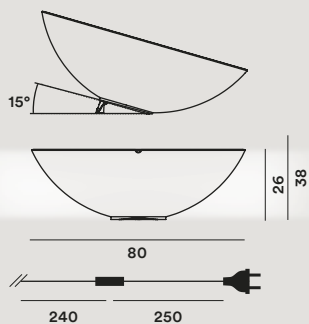

IP 44

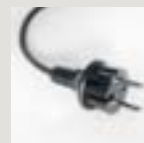

IP 65

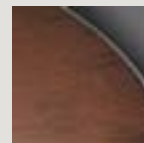



## Gregg outdoor

sospensione

Ludovica + Roberto Palomba,  
2011



Rotational moulded  
polyethylene and coated  
metal

*X-large / grande*  
LED retrofit or Fluo  
1x25W E27

*media*  
LED retrofit or Fluo  
1x15W E27

Canopy not included

IP 65 IP 44

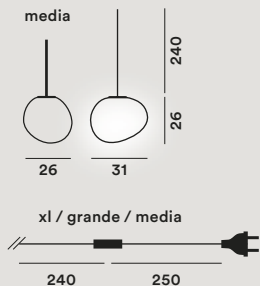
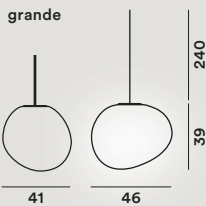
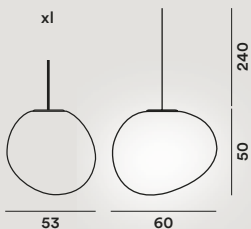

	energy cl.	colours	code	vat excluded
<i>Gregg outdoor X-large</i>	A <sup>+</sup> , A	bianco	218007 10	307,00
<i>Gregg outdoor X-large h. 5 m</i>	A <sup>+</sup> , A	bianco	218007SP5 10	336,00
<i>Gregg outdoor grande</i>	A <sup>+</sup> , A	bianco	218017 10	229,00
<i>Gregg outdoor grande h. 5 m</i>	A <sup>+</sup> , A	bianco	218017SP5 10	258,00
<i>Gregg outdoor media</i>	A <sup>+</sup> , A	bianco	218027 10	183,00
<i>Gregg outdoor media h. 5 m</i>	A <sup>+</sup> , A	bianco	218027SP5 10	212,00

### Spare parts:

<i>Lampshade Gregg outdoor X-large</i>	bianco	218S001 10	179,00
<i>Lampshade Gregg outdoor grande</i>	bianco	218S00 10	101,00
<i>Lampshade Gregg outdoor media</i>	bianco	218S002 10	63,00

Colours: bianco



Weight:  
*X-large*  
net kg 3,70

*grande*  
net kg 3,00

*media*  
net kg 1,40

Fluo, LED retrofit light  
bulbs not included  
→ specifications p. 182

collection →

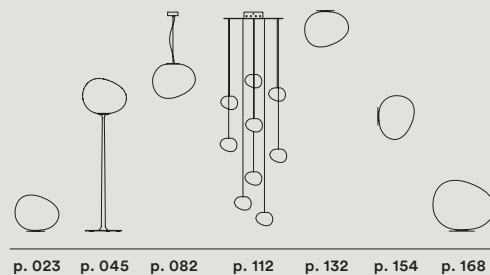

IP 44

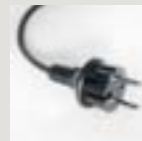

IP 65

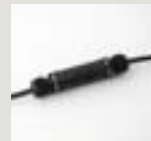

## Havana outdoor

sospensione

Jozeph Forakis, 2005



Rotational moulded polyethylene and coated metal

LED retrofit or Fluo  
1x15W E27  
Halo 1x46W E27

Canopy not included

IP 65 IP 44

	energy cl.	colours	code	vat excluded
<i>Havana outdoor</i>	A+, A, B, C	bianco	150007 10	347,00
<i>Havana outdoor h. 5 m</i>	A+, A, B, C	bianco	150007 10 SP5	392,00

### Spare parts:

<i>Lampshade Havana Outdoor</i>	bianco	150S00 10	155,00
---------------------------------	--------	-----------	--------

Colours: bianco



Weight:  
net kg 3,00

Halo, Fluo, LED retrofit  
light bulbs not included  
→ specifications p. 182

Tecnico — 2017

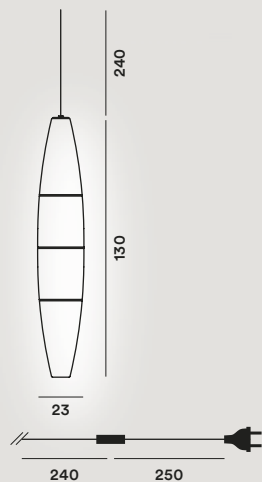

collection →

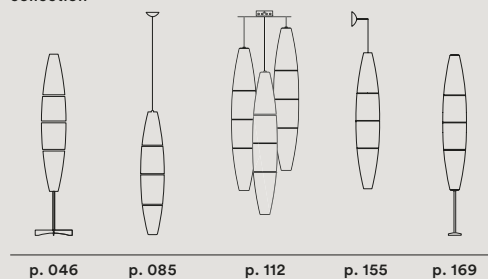

IP 44

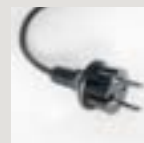

IP 65



**Uto**

Lagranja Design, 2005



	energy cl.	colours	code	vat excluded
<b>Uto</b>	A <sup>+</sup> , A	bianco	142000 10	<b>349,00</b>
		giallo	142000 50	
		arancio	142000 53	

Thermoplastic elastomer and polycarbonate

LED retrofit or Fluo  
1x15W E27

Switch inside the flexible tube

☐ ▽ CE ◀ IP 44

Colours: bianco, giallo, arancio



Special colours on request

Weight:  
net kg 2,00

Fluo, LED retrofit light bulbs not included  
→ specifications p. 182

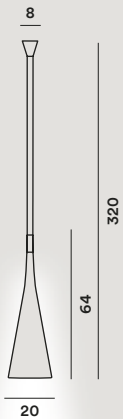

collection →

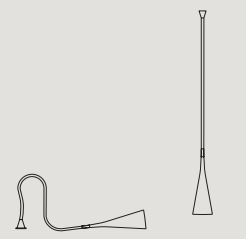

p. 036

p. 109

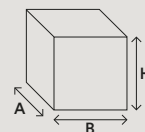

**Packing**

Model	Version		N° boxes	Description	net weight kg	gross weight kg	size cm A x B x H	
<b>Allegretto</b>	<i>Assai</i>	sospensione	1	set rodes	8,7	13,0	91x61x29	
			1	frame	2,6	5,0	47x47x34	
	<i>Ritmico</i>	sospensione	1	set rodes	2,7	4,5	66x41x25	
			1	frame	2,4	4,7	47x47x34	
	<i>Vivace</i>	sospensione	1	set rodes	6,4	8,7	84x39x27	
			1	frame	2,7	5,1	47x47x34	
<b>Allegro</b>	<i>Assai</i>	sospensione	1	set rodes	31,0	46,5	187x37x27	
			1	frame	5,0	6,5	43x43x34	
	<i>Ritmico</i>	sospensione	1	set rodes	10,0	11,9	97x53x25	
			1	frame	5,0	6,5	43x43x34	
	<i>Vivace</i>	sospensione	1	set rodes	14,3	16,7	111x44x27	
			1	frame	5,0	6,3	43x43x34	
<b>Anisha</b>	<i>grande</i>	tavolo	1		0,4	1,2	41x29x10	
	<i>piccola</i>	tavolo	1		0,7	1,7	51x37x10	
<b>Aplomb</b>		sospensione	1		1,9	2,9	29x29x51	
	<i>mini</i>	sospensione	1		1,9	2,9	36x19x16	
		terra	1	frame + diffuser	3,2	7,7	28x28x197	
			1	base	5,3	6,5	43x32x8	
		parete	1		1,9	2,8	30x30x52	
<b>Bahia</b>	<i>Fluo</i>	parete/soffitto	1		3,4	4,5	86x81x16	
	<i>LED</i>	parete	1		4,0	5,1	86x81x16	
	<i>mini</i>	parete/soffitto	1		2,0	4,3	62x62x18	
	<i>mini LED</i>	parete/soffitto	1		2,3	4,6	62x62x18	
<b>Behive</b>		sospensione	1	diffuser	2,3	4,7	49x49x41	
			1	frame	0,8	1,7	25x23x27	
		tavolo	1	diffuser	2,2	4,6	49x49x41	
			1	frame	1,5	2,2	21x21x34	
<b>Big Bang</b>		parete/soffitto	1	diffuser set	2,0	3,1	89x31x12	
			1	frame	1,0	1,4	23x23x9	
	<i>Halo</i>	sospensione	1	diffuser set	3,4	4,4	89x31x12	
			1	frame	2,0	3,3	89x31x12	
	<i>LED</i>	sospensione	1	diffuser set	3,4	4,4	89x31x12	
			1	frame	4,0	5,5	89x31x12	
<b>Big Bang L</b>		sospensione	1	diffuser set	13,0	15,0	134x41x9	
			1	frame	23,0	30,0	94x39x14	
			1	canopy	2,9	3,3	25x25x14	
<b>Big Bang xl</b>		sospensione	1	diffuser set	23,0	30,0	190x46x15	
			1	frame	12,0	15,0	131x58x50	
<b>Binic</b>		tavolo	1		0,6	1,3	22x22x14	
<b>Birdie</b>	<i>1</i>	soffitto	1	diffuser	0,4	0,8	23x23x26	
			1	canopy	0,6	1,0	18x18x8	
			1	frame	0,5	2,3	100x28x18	
	<i>3</i>	soffitto	3	diffuser	0,4	0,8	23x23x26	
			1	canopy	1,0	2,0	24x24x14	
			1	set 3 arms	1,5	5,1	106x59x18	
	<i>6</i>	soffitto	6	diffuser	0,4	0,8	23x23x26	
			1	canopy	1,2	2,0	24x24x14	
			2	set 3 arms	1,5	5,1	106x59x18	
	<i>9</i>	soffitto	9	diffuser	0,4	0,8	23x23x26	
			1	canopy	1,4	2,0	24x24x14	
			3	set 3 arms	1,5	5,1	106x59x18	
	<i>6</i>	sospensione	6	diffuser	0,4	0,8	23x23x26	
			1	canopy	1,2	2,0	20x19x20	
			2	set 3 arms	1,5	5,1	106x59x18	
9			sospensione	9	diffuser	0,4	0,8	23x23x26
1			canopy	1,4	2,0	20x19x20		
3			set 3 arms	1,5	5,1	106x59x18		

Model	Version	N° boxes	Description	net weight kg	gross weight kg	size cm A x B x H	
<b>Birdie</b>	<i>grande</i>	tavolo	1 diffuser	0,7	1,5	30x30x35	
			1 frame	3,3	5,4	79x30x27	
	<i>piccola</i>	tavolo	1 diffuser	0,4	0,8	23x23x26	
			1 frame	1,6	3,0	26x26x53	
	<i>grande</i>	sospensione	1 diffuser	0,7	1,5	30x30x35	
			1 frame	0,7	1,7	20x20x29	
	<i>piccola</i>	sospensione	1 diffuser	0,4	0,8	23x23x26	
			1 frame	0,3	0,6	18x18x26	
		lettura	1 diffuser	0,7	1,5	30x30x35	
			1 frame	3,6	7,8	159x29x27	
		parete	1 diffuser	0,4	0,8	23x23x26	
			1 frame	1,2	2,5	50x20x29	
		<i>Metal grande</i>	tavolo	1	3,8	7,5	82x82x37
		<i>Metal piccola</i>	tavolo	1	2,0	3,9	59x27x27
<b>Bit</b>	1	parete	1 glass	1,1	2,3	61x52x11	
			1 frame	0,6	1,0	19x19x14	
	2	parete	1 glass	0,4	2,3	51x37x11	
			1 frame	0,6	1,0	19x19x14	
	3	parete	1 glass	1,2	2,3	61x52x11	
			1 frame	0,6	1,0	19x19x14	
	4	parete	1 glass	0,6	2,3	51x37x11	
			1 frame	0,6	1,0	19x19x14	
	5	parete	1 glass	0,8	2,3	51x37x11	
			1 frame	0,6	1,0	19x19x14	
<b>Blob s</b>		parete/soffitto	1 diffuser	0,6	0,9	48x17x17	
			1 frame	0,5	0,8	48x13x9,5	
<b>Buds</b>	1	sospensione	1 glass	2,5	5,3	32x32x45	
			1 frame	0,7	0,9	19x19x14	
	2	sospensione	1 glass	3,5	5,0	51x51x34	
			1 frame	0,7	0,9	19x19x14	
	3	sospensione	1 glass	2,5	3,5	38x38x33	
			1 frame	0,7	0,9	19x19x14	
	<i>1 LED</i>	sospensione	1 glass	2,5	5,3	32x32x45	
			1 frame	1,3	2,0	28x23x20	
	<i>2 LED</i>	sospensione	1 glass	3,5	5,0	51x51x34	
			1 frame	1,3	2,0	28x23x20	
	<i>3 LED</i>	sospensione	1 glass	2,5	3,5	38x38x33	
			1 frame	1,3	2,0	28x23x20	
	1	tavolo	1 glass	2,5	5,3	32x32x45	
			1 frame	2,5	3,5	17x17x32	
	2	tavolo	1 glass	3,5	5,0	51x51x34	
			1 frame	2,5	3,5	17x17x32	
3	tavolo	1 glass	2,5	3,5	38x38x33		
		1 frame	1,9	3,0	17x17x35		
<b>Caboche</b>	<i>grande Halo</i>	sospensione	1 set sphere	12,1	13,5	51x51x15	
			1 frame	7,5	9,0	69x69x38	
	<i>grande LED</i>	sospensione	1 set sphere	12,1	13,5	51x51x15	
			1 frame	4,9	7,7	69x69x38	
	<i>terra</i>	sospensione	1 set sphere	12,1	13,5	51x51x15	
			1 frame	10,5	12,4	69x69x52	
			1 set stem	1,3	2,0	155x11x12	
	<i>media Halo</i>	sospensione	1 set sphere	6,4	7,2	38x38x14	
			1 frame	3,8	4,9	52x52x28	
	<i>media LED</i>	sospensione	1 set sphere	6,4	7,2	38x38x14	
			1 frame	3,8	5,1	52x52x28	
	<i>media</i>	parete	1 set sphere	2,7	3,5	31x26x15	
		1 frame	1,8	2,6	45x17x38		

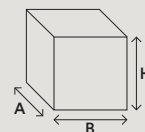
**Packing**

Model	Version	N° boxes	Description	net weight kg	gross weight kg	size cm A x B x H	
<b>Caboche</b>	terra	1	set sphere	6,4	7,2	38x38x14	
		1	frame	4,4	6,5	51x51x36	
		1	set stem	1,0	1,7	155x11x12	
	<b>piccola</b>	parete	1	set sphere	1,5	2,2	34x20x11
			1	frame	1,1	2,0	18x29x32
		sospensione	1	set sphere	3,2	3,8	47x24x11
			1	frame	1,6	2,0	29x29x38
	tavolo	1	set sphere	3,2	3,8	47x24x11	
		1	frame	2,1	2,5	29x29x51	
	<b>soffitto</b>		1	set sphere	5,2	6,4	38x35x15
1			frame	3,9	4,8	52x52x28	
<b>Caiigo</b>		1		2,0	3,0	28x28x36	
<b>Chouchin &amp; reverse</b>	1	sospensione	1	glass	3,7	5,4	51x51x44
			1	frame	0,7	0,8	19x19x14
	2	sospensione	1	glass	2,2	3,6	34x34x55
			1	frame	0,7	1,0	19x19x14
	3	sospensione	1	glass	2,9	3,6	38x38x33
			1	frame	0,7	0,8	19x19x14
	1 LED	sospensione	1	glass	3,7	5,4	51x51x44
			1	frame	1,3	2,0	28x23x20
	2 LED	sospensione	1	glass	2,2	3,6	34x34x55
			1	frame	1,3	2,0	28x23x20
	3 LED	sospensione	1	glass	2,9	3,6	38x38x33
			1	frame	1,3	2,0	28x23x20
<b>Chouchin mini</b>	1	sospensione	1	1,0	1,6	28x22x19	
	2	sospensione	1	1,0	1,7	29x23x20	
<b>Circus</b>	<b>grande</b>	parete/soffitto	1	glass	3,0	4,4	51x51x15
			1	frame	1,7	2,7	42x42x17
	<b>piccola</b>	parete/soffitto	1	glass	1,6	2,0	42x42x17
			1	frame	0,5	0,7	19x19x14
<b>Colibri</b>	lettura	1	frame+diffuser	1,4	4,0	152x23x23	
		1	base	3,7	4,6	34x34x12	
<b>Doll</b>	tavolo	1		0,7	1,4	22x22x29	
<b>Double</b>	parete	1	diffuser	1,5	1,9	36x36x23	
		1	frame	0,5	0,7	25x15x10	
<b>Ellepi</b>	parete/soffitto	1	diffuser	2,0	3,5	82x72x17	
		1	frame	2,3	3,5	61x51x17	
<b>Esa</b>	<b>grande</b>	tavolo	1	glass	2,0	3,0	52x37x27
			1	frame	1,2	2,0	52x37x27
	<b>piccola</b>	tavolo	1	glass	1,4	1,7	34x22x23
			1	frame	0,6	1,0	27x22x32
<b>Falena</b>	1	parete	1	0,8	1,1	31x17x15	
	2	parete/soffitto	1	3,0	3,8	86x17x15	
	3	parete/soffitto	1	5,2	6,2	145x17x15	
<b>Fields</b>	1	parete	1		6,0	8,0	177x22x14
			1	diffuser set	1,3	1,5	76x25x4
	3	parete	1	frame	5,2	7,5	134x25x31
			1	diffuser set	1,3	1,6	60x32x3
			1	frame	4,5	6,1	104x25x25
<b>Flip</b>	parete	1		1,2	2,3	40x37x23	
<b>Folio</b>	<b>grande</b>	parete	1	glass	1,6	3,0	62x52x18
			1	frame	0,6	0,9	56x13x10
			1	glass	1,6	3,0	62x52x18
	<b>piccola</b>	parete	1	frame	0,6	1,1	57x27x11
			1	glass	1,0	1,3	38x35x15
			1	frame	0,5	0,8	37x13x10

Model	Version	N° boxes	Description	net weight kg	gross weight kg	size cm A x B x H	
<i>Giga-Lite</i>	sospensione	1	diffuser	1,5	2,7	57x57x46	
		1	frame	1,0	1,6	29x27x23	
	terra	1	diffuser	1,5	2,7	57x57x46	
		1	frame	8,3	10,9	144x30x14	
<i>Gregg</i>	<i>grande</i>	sospensione	1	glass	5,0	7,0	56x48x47
		1	frame	0,6	0,7	19x19x14	
	<i>grande LED</i>	sospensione	1	glass	5,0	7,0	56x48x47
		1	frame	1,3	2,0	28x23x20	
		tavolo	1	glass	5,0	7,0	56x48x47
		1	frame	1,8	2,5	23x23x19	
	<i>grande alta</i>	terra	1	glass	5,0	7,0	56x48x47
		1	base	7,2	8,3	55x55x3	
		1	frame	2,5	5,0	166x20x20	
	<i>media alta</i>	terra	1	glass	2,5	2,8	38x33x30
		1	base	7,2	8,3	55x55x3	
		1	frame	2,5	5,0	166x20x20	
	<i>media</i>	parete/soffitto	1	glass	2,5	2,8	38x33x30
			1	frame	0,4	0,7	19x19x18
		sospensione	1	glass	2,5	2,8	38x33x30
		1	frame	0,6	0,7	19x19x14	
	<i>media LED</i>	sospensione	1	glass	2,5	2,8	38x33x30
			1	frame	1,3	2,0	28x23x20
		tavolo	1	glass	2,5	2,8	38x33x30
		1	frame	0,8	1,2	19x19x18	
<i>piccola</i>	parete/soffitto	1		0,6	0,9	27x19x20	
		1	sospensione	0,7	0,9	27x19x20	
		1	tavolo	0,6	0,9	27x19x20	
<i>Havana outdoor</i>	sospensione	1	diffuser	2,0	3,3	25x25x132	
	1	frame	1,0	1,4	64x13x10		
	<i>base</i>	terra	1	diffuser	2,0	3,3	25x25x132
		1	base	6,1	6,5	37x37x3	
		1	frame	2,0	2,9	107x14x14	
	<i>cilindro</i>	terra	1	diffuser	2,0	3,3	25x25x132
		1	underground base	0,5	0,7	15x14x24	
		1	frame	3,0	4,0	107x14x14	
	<i>picchetto</i>	terra	1	diffuser	2,0	3,3	25x25x132
		1	stake mounted	1,2	1,5	14x13x46	
		1	frame	2,0	2,5	107x14x14	
	<i>bassa base</i>	terra	1	diffuser	2,0	3,3	25x25x132
		1	base	6,1	6,5	37x37x3	
		1	frame	2,0	2,9	107x14x14	
	<i>bassa cilindro</i>	terra	1	diffuser	2,0	3,3	25x25x132
		1	underground base	0,5	0,7	15x14x24	
		1	frame	3,0	3,8	107x14x14	
	<i>bassa picchetto</i>	terra	1	diffuser	2,0	3,3	25x25x132
		1	stake mounted	1,2	1,5	14x13x46	
		1	frame	1,5	2,4	107x14x14	
<i>Havana</i>	sospensione/parete	1	diffuser set	1,3	1,8	49x25x25	
		1	frame	0,6	0,8	19x19x14	
	terra	1	diffuser set	1,3	1,8	49x25x25	
	1	frame	2,0	3,0	100x29x15		
<i>Innerlight</i>	parete	1	diffuser set	3,3	4,3	79x20x26	
		1	frame	1,7	3,0	69x30x16	
<i>Jamaica</i>	sospensione	1	diffuser set	2,3	5,9	81x81x27	
		1	frame	3,7	5,4	174x15x20	
<i>Kite</i>	parete	1	diffuser	0,3	1,3	52x37x27	
		1	frame	0,2	0,6	26x16x11	

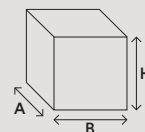
**Packing**

Model	Version	N° boxes	Description	net weight kg	gross weight kg	size cm A x B x H
<b>Kurage</b>		1		0,7	3,5	39x39x65
<b>Lake</b>	parete	1	diffuser	1,3	2,5	58x50x12
		1	frame	0,4	0,7	18x18x17
<b>Le Soleil</b>	parete	1	diffuser set	0,8	1,5	38x31x12
		1	frame	0,8	1,3	28x22x11
	sospensione	1	diffuser set	4,1	6,0	61x61x23
		1	frame	1,2	2,2	25x25x33
<b>Lightweight</b>	sospensione	1		7,6	21,6	113x112x82
<b>Lightwing</b>	terra	1	frame+diffuser	6,0	14,0	185x38x31
		1	base	5,0	6,0	30x30x12
<b>Lumiere</b>	<i>grande</i>	tavolo	1 glass	1,5	2,1	33x33x26
			1 frame	0,9	1,4	49x25x25
	<i>piccola</i>	tavolo	1 glass	0,6	1,2	26x26x21
			1 frame	0,5	0,8	21x40x19
<b>Lumiere xxl</b>	parete/soffitto	1	glass	1,8	2,1	41x41x20
		1	frame	1,6	3,0	42x42x17
	tavolo	1	glass	4,0	5,3	50x50x37
		1	frame	1,5	2,8	38x38x61
<b>Lumiere xxs</b>	parete/soffitto	1	glass	1,0	1,6	31x31x17
		1	frame	0,8	1,7	30x30x10
	tavolo	1	glass	1,2	2,3	33x33x26
		1	frame	0,6	1,7	43x27x27
	lettura	1	glass	0,4	5,3	50x50x37
		1	frame	12,5	13,5	155x42x16
	lettura	1		2,8	5,0	130x24x5
	tavolo	1		1,3	1,8	41x24x7
<b>Maki</b>	sospensione	1		0,5	0,8	31x17x15
<b>Mite</b>	terra	1		7,0	11,1	28x28x197
<b>New Buds</b>	1	sospensione	1 glass	2,5	5,3	36x36x63
			1 frame	0,7	0,9	19x19x14
<b>New Buds</b>	2	sospensione	1 glass	3,5	5,0	50x50x37
			1 frame	0,7	0,9	19x19x14
<b>New Buds</b>	3	sospensione	1 glass	2,5	3,5	38x38x33
			1 frame	0,7	0,9	19x19x14
<b>Nuage</b>	parete/soffitto	1	diffuser set	1,4	3,6	71x71x16
		1	frame	1,8	3,0	41x41x13
<b>Orbital</b>	terra	1	glass set	4,1	5,5	71x52x13
		1	frame	6,0	9,7	185x32x27
<b>O-Space</b>	sospensione	1		4,4	6,0	67x55x42
<b>Gregg outdoor</b>	<i>grande</i>	sospensione	1 diffuser	2,3	3,5	50x42x39
			1 frame	0,7	1,5	20x17x26
	terra	1	diffuser	2,3	3,5	50x42x39
		1	frame	1,3	2,3	28x28x15
	<i>media</i>	sospensione	1 diffuser	0,7	1,4	33x28x26
			1 frame	0,7	1,5	20x17x26
	terra	1	diffuser	0,7	1,4	33x28x26
		1	frame	0,9	1,7	21x21x15
	<i>xl</i>	sospensione	1 diffuser	3,0	5,4	63x53x50
			1 frame	0,7	1,2	20x17x26
	terra	1	diffuser	3,0	5,4	63x53x50
		1	frame	1,3	2,3	28x28x15
<b>Planet</b>	<i>grande</i>	sospensione	1 diffuser	1,2	4,5	81x81x41
			1 frame	1,4	2,6	29x29x32
	<i>piccola</i>	sospensione	1 diffuser	0,6	2,2	56x56x26
			1 frame	1,4	2,6	29x29x32
<b>Plass</b>	<i>grande</i>	sospensione	1 diffuser	18,0	24,0	119x79x79
			1 frame	5,0	10,0	129x31x31

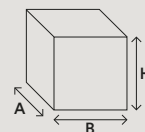

Model		Version	N° boxes	Description	net weight kg	gross weight kg	size cm A x B x H	
<i>Plass</i>	<i>media</i>	sospensione	1	diffuser	2,8	3,5	36x36x52	
			1	frame	0,7	1,2	47x22x14	
		tavolo	1	diffuser	2,8	3,5	36x36x52	
			1	frame	1,2	2,0	22x22x32	
<i>Polygregg</i>	<i>grande</i>	tavolo	1	diffuser	2,3	3,5	50x42x39	
			1	frame	1,3	1,9	28x28x15	
	<i>media</i>	tavolo	1	diffuser	0,7	1,4	33x28x26	
			1	frame	0,9	1,4	21x21x15	
	<i>xl</i>	tavolo	1	diffuser	3,0	5,4	63x53x50	
			1	frame	1,3	1,9	28x28x15	
<i>Rituals</i>	<i>1</i>	parete	1	glass	3,4	4,0	33x33x40	
			1	frame	1,4	2,0	28x19x18	
		soffitto	1	glass	3,4	4,0	33x33x40	
			1	frame	0,7	1,1	19x19x21	
		sospensione	1	glass	3,4	4,0	33x33x40	
			1	frame	0,5	0,8	19x19x14	
		tavolo	1	glass	3,4	4,0	33x33x40	
			1	frame	0,6	1,2	26x25x18	
		<i>2</i>	soffitto	1	glass	3,5	4,0	41x41x26
				1	frame	0,7	1,01	19x19x21
			sospensione	1	glass	3,5	4,0	41x41x26
				1	frame	0,5	0,8	19x19x14
	tavolo		1	glass	3,5	4,0	41x41x26	
			1	frame	0,6	1,2	26x25x18	
	<i>3</i>	parete	1	glass	1,0	1,6	25x25x26	
			1	frame	1,4	2,0	28x19x18	
		soffitto	1	glass	1,0	1,6	25x25x26	
			1	frame	0,7	1,1	19x19x21	
		sospensione	1	glass	1,0	1,6	25x25x26	
			1	frame	0,5	0,8	19x19x14	
		tavolo	1	glass	1,0	1,6	25x25x26	
			1	frame	0,6	1,2	26x25x18	
		<i>xl</i>	tavolo	1	diffuser	5,4	8,4	51x54x50
				1	frame	1,2	2,0	22x22x32
sospensione			1	diffuser	5,4	8,4	51x54x50	
			1	frame	0,6	0,7	19x19x14	
<i>xl LED</i>	sospensione		1	diffuser	5,4	8,4	51x54x50	
			1	frame	1,3	2,0	28x23x20	
<i>Solar outdoor</i>	terra	1	diffuser	9,4	13,7	87x87x27		
		1	frame	2,3	3,6	31x31x17		
<i>Spokes</i>	<i>1</i>	sospensione	1	canopy	1,0	1,1	24x24x9	
			1	structure	4,5	6,0	41x41x80	
	<i>2</i>	sospensione	1	canopy	1,0	1,1	22x22x8	
			1	structure	5,0	6,5	60x60x61	
	<i>2 large</i>	sospensione	1	canopy	1,0	1,1	24x24x9	
			1	structure	6,0	7,5	80x80x83	
<i>Supernova</i>		sospensione	1		8,0	10,6	82x72x17	
<i>Tartan</i>		sospensione	1	diffuser	4,0	6,5	49x49x44	
			1	frame	0,7	0,8	19x19x14	
<i>Tartan</i>	<i>LED</i>	sospensione	1	diffuser	4,0	6,5	49x49x44	
			1	frame	1,9	3,0	17x17x35	
<i>Tite</i>	<i>1</i>	sospensione	1	diffuser	0,8	2,0	123x29x30	
			1	frame	0,6	1,2	80x16x14	
	<i>2</i>	sospensione	1	diffuser	0,5	1,3	64x27x27	
			1	frame	0,5	1,1	45x16x14	
<i>Tivù</i>	<i>grande</i>	parete/soffitto	1		1,3	2,0	46x27x13	
	<i>piccola</i>	parete	1		0,3	0,7	22x17x11	

**Packing**

Model	Version	N° boxes	Description	net weight kg	gross weight kg	size cm A x B x H
<b>Tress</b>	<i>grande</i>	1	diffuser	0,4	1,6	68x32x19
		1	frame	0,7	0,9	36x12x9
<b>Tress</b>		1	diffuser	1,1	2,9	51x51x44
		1	frame	3,8	3,7	46x46x23
	<i>grande LED</i>	1	diffuser	1,1	2,9	51x51x44
		1	frame	2,0	3,3	89x31x12
	<i>grande Halo</i>	1	frame+diffuser	5,0	8,5	200x30x34
		1	base	5,5	6,0	26x26x3
		1	frame+diffuser	3,0	7,0	200x30x34
		1	base	5,5	6,0	26x26x3
	<i>media</i>	1	diffuser	1,6	3,5	118x30x30
		1	frame	0,8	1,0	21x21x15
		1	diffuser	1,6	3,5	118x30x30
		1	frame	2,3	2,5	28x28x15
		1	diffuser	0,9	1,8	61x61x23
		1	frame	2,3	2,5	28x28x15
	<i>piccola</i>	1	diffuser	0,3	1,5	48x32x19
		1	frame	0,8	1,0	36x12x9
		1	diffuser	0,9	1,8	61x61x23
		1	frame	0,8	1,0	21x21x15
	<i>mini</i>	1	diffuser	0,4	1,4	52x26x26
		1	frame	0,7	0,8	19x19x14
		1	diffuser	0,4	1,4	52x26x26
		1	frame	1,0	2,0	21x21x15
<b>Tress Stilo</b>		1		0,5	1,2	76x12x12
		1	frame+diffuser	1,6	4,5	205x21x21
		1	base	2,6	2,9	30x30x4
		1		3,5	6,0	227x16x15
		1		2,8	5,2	197x16x15
<b>Troag</b>	<i>piccola</i>	1		1,8	3,9	137x16x15
<b>Tropico</b>	<i>Ellipse</i>	1	set elements	3,8	4,5	38x38x11
		1	set rings	1,3	2,6	72x72x6
		1	frame	1,0	2,7	52x26x26
		1	set of filters	0,5	0,3	48x6x6
		1	set elements	3,3	4,5	38x38x11
		1	set rings	1,7	2,5	63x63x6
		1	frame	1,0	3,3	73x26x26
	<i>Sphera</i>	1	set of filters	0,5	0,3	48x6x6
		1	set elements	3,8	4,5	38x38x11
		1	set rings	2,9	3,5	33x33x15
		1	frame	1,0	5,2	161x26x26
		1	set of filters	0,5	0,3	48x6x6
		1	set of filters	0,5	0,3	48x6x6
<b>Tuareg</b>	terra	1	structure	2,8	4,2	87x87x106
		1	base	6,4	8,8	157x24x17
		1	glass	0,5	1,2	37x18x24
<b>Tutù</b>	parete	1	frame	0,3	0,7	36x12x9
		1	diffuser	5,4	8,4	85x85x56
<b>Twice as Twiggy</b>	sospensione	1	canopy	2,9	3,3	25x25x14
		1	diffuser	1,6	2,8	51x51x32
<b>Twiggy</b>	sospensione	1	frame	0,8	1,1	56x16x17
		1	diffuser	1,0	2,1	51x51x32
		1	frame	1,5	3,0	164x21x22
		1	base	8,3	8,7	55x55x6
		1	diffuser	1,6	2,8	51x51x32
		1	frame	4,0	6,0	194x30x18

Model	Version	N° boxes	Description	net weight kg	gross weight kg	size cm A x B x H
<i>Twiggy</i>	terra	1	diffuser	1,6	2,8	51x51x32
		1	frame	1,5	3,9	187x21x23
		1	base	13,5	15,3	69x69x7
		1	stem set	0,1	0,4	96x6x7
<i>LED</i>	terra	1	diffuser	1,6	3,5	51x51x32
		1	frame	2,0	3,0	171x19x12
		1	base	13,5	15,3	69x69x7
<i>Twiggy xl</i>	tavolo	1	diffuser	1,1	1,5	69x22x23
		1	frame	1,1	1,5	68x21x22
		1	base	4,7	5,5	45x45x6
<i>Uto</i>		1		2,0	3,4	80x30x22
<i>Wave</i>	sospensione	1		6,0	10,7	237x50x18
<i>Yoko</i>	tavolo	1	diffuser	0,6	1,0	25x25x33
		1	frame	1,4	2,1	38x21x21
<b>Accessories:</b>						
<i>Rosone multiplo</i>	<i>tondo</i>	1		9,0	10,7	61x61x9
	<i>lineare 90</i>	1		6,8	7,7	100x27x9
	<i>lineare 135</i>	1		10,0	11,5	145x27x9

## Light Sources

According to the European norms, starting from 1st of September, the lighting fixtures equipped with bulbs that can be replaced by the final user have to be compatible with A+ bulbs (LED retrofit). The Foscarini lamps comply already with this requirement. Since a couple of years our price list states the possibility to use led retrofit bulbs besides the recommended halogen bulbs.

If the fixture is supplied with a Pyrex glass, it has to be removed.

If a dimmer is foreseen (whether included or not), it has to be used at full power in order to avoid damages to the retrofit bulb.

Even when using dimmable led retrofit bulbs, the correct dimming function is not granted.

The actual state of the art of LED retrofit bulbs does not allow to obtain the same light flux as the halogen bulbs recommended by Foscarini.







In order to give a more complete information, we remind you that the exit of halogen bulbs from the EU market has presently been postponed to September 1, 2018.











This table contains the necessary information to purchase the correct light source (Foscarini models with integrated LED excluded).

The light tones may vary from one bulb to another. Foscarini recommends the use of warm light bulbs for its whole collection.

The light bulbs available on the market may feature technical specifications with various graphics and definitions, but a warm light tone is generally described as: Warm White - 2700- 3000K° and CRI > 80.

\* Expressed in mm

Model	Version	Type	Fitting Base	Length*	Width*	Notes
<i>Allegretto</i>	sospensione	Halo / LED retrofit	E27-PAR	max 85	Ø96	
<i>Allegro</i>	sospensione	Halo / LED retrofit	E27-PAR / R7s	max 99 (E27 PAR) 118 (R7s)	Ø96	
<i>Aplomb GU 10-Aplomb mini</i>	sospensione	LED retrofit	GU10-PAR	max 80	Ø80	
<i>Aplomb G9</i>	sospensione	Halo / LED retrofit	G9	max 60	max Ø18	
<i>Aplomb</i>	terra	Halo / LED retrofit	R7s	78	max Ø23	
<i>Bahia-Bahia mini</i>	soffitto/parete	Fluo	2GX13 T16-R	300/230	Ø16	
<i>Behive</i>	tavolo	Halo / LED retrofit dimm.	E27		max Ø65	
<i>Behive</i>	sospensione	LED retrofit / Fluo / Halo	E27		max Ø65	
<i>Big Bang</i>	sospensione	Halo / LED retrofit	R7s	118	max Ø23	
<i>Big Bang</i>	sospensione	Fluo	GX24q-3	130	//	
<i>Big Bang</i>	soffitto/parete	Halo / LED retrofit	R7s	78	max Ø23	
<i>Binic</i>	tavolo	LED retrofit / Fluo	E14	max 110	max Ø40	
<i>Birdie</i>	tavolo grande /terra /sosp gr.	LED retrofit / Fluo / Halo	E27	max 180	max Ø120	
<i>Birdie</i>	tav. piccolo /sosp./soff./par.	LED retrofit / Fluo / Halo	E27	max 110	max Ø80	
<i>Bit</i>	parete	LED retrofit / Fluo / Halo	E14	max 140	max Ø45	
<i>Blob</i>	soffitto/parete	Fluo	2G11	320	//	
<i>Buds</i>	tavolo / sospensione	LED retrofit / Fluo	E27	white globe Ø 120 for Buds 1-2 Ø 90 for Buds 3		
<i>Caboche</i>	sospensione piccola/tavolo	Halo / LED retrofit	G9	max 60	max Ø18	
<i>Caboche</i>	terra/sospensione/soffitto	Halo / LED retrofit	R7s	118	max Ø23	
<i>Caboche</i>	parete	Halo / LED retrofit	R7s	78	max Ø23	
<i>Caigo</i>	sospensione	LED retrofit / Halo	GU10-PAR	max 62	max Ø51	
<i>Chouchin 1-2-3 &amp; reverse</i>	sospensione	LED retrofit / Fluo / Halo	E27/E27 PAR	max 150	max Ø100	
<i>Chouchin mini</i>	sospensione	LED retrofit / Halo	GU10-PAR	max 60	max Ø55	
<i>Circus grande</i>	soffitto/parete	LED retrofit / Fluo / Halo	E27	max 100	max Ø70	
<i>Circus piccola</i>	soffitto/parete	LED retrofit / Fluo / Halo	E14	max 70	max Ø50	
<i>Colibri</i>	terra	Halo / LED retrofit dimm.	GU10-PAR	max 65	max Ø65	
<i>Doll</i>	tavolo	LED retrofit / Fluo	E14	max 110	max Ø60	
<i>Double</i>	parete	LED retrofit / Fluo / Halo	E27	max 110	max Ø60	
<i>Ellepi</i>	soffitto/parete	Fluo	2GX13 T16-R	300	Ø16	
<i>Esa grande</i>	tavolo	LED retrofit / Fluo / Halo	E14	max 130	max Ø66	
<i>Esa piccola</i>	tavolo	Halo / LED retrofit	G9	max 60	max Ø18	
<i>Falena 1</i>	parete	Halo	R7s	78	max Ø23	
<i>Falena 2-3</i>	soffitto/parete	Fluo	G5	549/1149	Ø16	
<i>Fields 1-2-3</i>	parete	Fluo	G5	1449/1149/849	Ø16	
<i>Flip</i>	parete	Halo	R7s	78	max Ø23	
<i>Folio grande piccola</i>	soffitto/parete	Halo / LED retrofit	R7s	78	max Ø23	
<i>Giga-Lite</i>	terra/sospensione	LED retrofit dimmerabile / Fluo dimmerabile / Halo *	E27	max 150	max Ø80	
<i>Gregg grande</i>	tavolo/sospensione/terra	LED retrofit dimmerabile / Fluo dimmerabile / Halo *	E27	max 140	max Ø60	
<i>Gregg media</i>	tavolo/terra/sosp./soff./par.	LED retrofit dimmerabile / Fluo dimmerabile / Halo *	E27	max 140	max Ø60	

Model	Version	Type	Fitting Base	Lenght*	Width*	Notes
<i>Gregg piccola</i>	tavolo/sosp./soffitto/parete	Halo / LED retrofit	G9	max 60	max Ø18	
<i>Havana</i>	terra/sospensione/parete	LED retrofit dimmerabile / Fluo dimmerabile / Halo *	E27	max 125	max Ø60	
<i>Havana outdoor</i>	terra/sospensione	LED retrofit / Fluo / Halo	E27		max Ø55	
<i>Innerlight</i>	parete	Fluo	2G11	415	//	
<i>Kite</i>	parete	LED retrofit / Fluo / Halo	E14		max Ø50	
<i>Kurage</i>	tavolo	LED retrofit / Fluo	E27	max 135	max Ø65	
<i>Jamaica</i>	sospensione	Fluo	G5	1449	Ø16	
<i>Le Soleil</i>	sospensione	Halo / LED retrofit	G9/GU10 PAR			
<i>Le Soleil</i>	sospensione	Fluo	GX24q-4	155	//	
<i>Le Soleil</i>	parete	Fluo	GX24q-3	130	//	
<i>Lightweight</i>	sospensione	Halo	G4 12v			
<i>Lumiere grande piccola</i>	tavolo	Halo / LED retrofit	G9	max 60	max Ø18	
<i>Lumiere xxl xxs</i>	tavolo	Halo / LED retrofit	G9	max 60	max Ø18	
<i>Lumiere xxl</i>	soffitto/parete	Fluo	2GX13 T16-R	300	Ø16	
<i>Lumiere xxs</i>	soffitto/parete	Fluo	2G24q-2	140	//	
<i>Maki</i>	sospensione	LED retrofit / Halo	GU10-PAR		max Ø55	
<i>Mite</i>	terra	Halo / LED retrofit dimm.	E27	max 105	max Ø40	
<i>New Buds</i>	sospensione	LED retrofit / Fluo / Halo	E27	max 150	max Ø60	
<i>Nuage</i>	soffitto/parete	Fluo	2GX13 T16-R	300/230	Ø16	
<i>Orbital</i>	terra	Halo	E14	max 85	max Ø45	
<i>O-Space</i>	sospensione	Halo / LED retrofit	R7s	78	max Ø23	
<i>Planet</i>	sospensione	LED retrofit / Fluo / Halo	E27		max Ø180	
<i>Plass media</i>	tavolo	LED retrofit dimmerabile / Fluo dimmerabile / Halo *	E27		max Ø60	
<i>Plass media</i>	sospensione	LED retrofit / Fluo / Halo	E27		max Ø60	
<i>Plass grande</i>	sospensione	Halo	G9/GU10 PAR		max Ø60 <sup>(GU10 PAR)</sup>	
<i>Polygregg grande</i>	tavolo	LED retrofit / Fluo	E27		max Ø60	
<i>Gregg outdoor xl - grande</i>	tavolo/terra out./ sosp. out.	LED retrofit / Fluo	E27		max Ø60	
<i>Polygregg media</i>	tavolo	LED retrofit / Fluo	E27	max 140	max Ø60	
<i>Gregg outdoor media</i>	tavolo/terra out./sosp. out.	LED retrofit / Fluo	E27	max 140	max Ø60	
<i>Rituals 1-2-3 G9</i>	tavolo/sospensione	Halo / LED retrofit	G9			
<i>Rituals 1-2-3</i>	tavolo/sosp./soffitto/parete	LED retrofit dimmerabile / Fluo dimmerabile / Halo *	E27	max 110	max Ø70	
<i>Rituals xl</i>	tavolo/sospensione	LED retrofit dimmerabile / Fluo dimmerabile / Halo *	E27	max 140	max Ø60	
<i>Solar</i>	outdoor	LED retrofit / Fluo	E27	max 135	max Ø150	
<i>Stewie</i>	terra	Fluo	2GX13 T16-R	300	Ø16	
<i>Supernova</i>	sospensione	LED retrofit / Fluo	E27	max 160	max Ø120	
<i>Tartan</i>	sospensione	LED retrofit / Fluo / Halo	E27		max Ø60	
<i>Tite</i>	sospensione	LED retrofit / Fluo / Halo	E27		max Ø150	
<i>Tivu grande</i>	soffitto/parete	Fluo	2G11	225	//	
<i>Tivu piccola</i>	parete	Halo / LED retrofit	G9	max 60	max Ø18	
<i>Tress stilo</i>	terra	Halo / LED retrofit dimm	E27-PAR	max 100	100	
<i>Tress grande</i>	sospensione	Halo / LED retrofit	R7s	118	max Ø150 <sup>(E27 PAR)</sup> max Ø23 <sup>(R7s)</sup>	
<i>Tress</i>	parete	Halo / LED retrofit	R7s	78	max Ø23	
<i>Tress media/piccola</i>	tavolo/terra/sospensione	LED retrofit dimmerabile / Fluo dimmerabile / Halo *	E27/E27 PAR		max Ø150	
<i>Tress grande</i>	terra	Halo / LED retrofit	R7s/E27 PAR	118 <sup>(R7s)</sup>	max Ø150 <sup>(E27 PAR)</sup>	
<i>Tress mini</i>	tavolo/sospensione	Halo / LED retrofit dimm	GU10-PAR		max Ø150	
<i>Troag 1-2-3</i>	sospensione	Fluo	G5	1449/1149/549	Ø16	
<i>Tropico Vertical</i>	sospensione	Fluo	2G11	535	//	
<i>Tropico Sphera /Elipse</i>	sospensione	Fluo	2G24q-4	155	//	
<i>Tutù</i>	parete	LED retrofit / Fluo / Halo	E14	max 85	max Ø40	
<i>Twiggy</i>	tav./ter./lettura/sosp./soffitto	LED retrofit dimmerabile / Fluo dimmerabile / Halo *	E27	max 130	max Ø75	
<i>Uto</i>	tavolo/sospensione/outdoor	LED retrofit / Fluo	E27	max 160	max Ø100	
<i>Yoko</i>	tavolo	LED retrofit / Fluo	E27	max 160	max Ø70	
<i>Wave</i>	sospensione	Halo / LED retrofit	R7s	78	max Ø23	

Foscarini SpA

via delle Industrie 27

30020 Marcon / Venezia / Italy

T +39 041 595 3811

F +39 041 595 3820

foscarini@foscarini.com

Foscarini Inc

17 Greene Street, New York

NY /10013 / USA

T +1 212 247 2218

F +1 646 545 2564

foscarini.inc@foscarini.com

Foscarini Spazio Brera

via Fiori Chiari 28 /

via Pontaccio 19

20121 / Milano / Italy

T +39 02 870 71320

spaziobrera@foscarini.com

Foscarini Spazio Soho

17 Greene Street, New York

NY /10013 / USA

T +1 212 257 4412

spaziosoho@foscarini.com

Azienda certificata

UNI EN ISO 9001

UNI EN ISO 14001

edition 11.2016

Concept and graphic design:

Designwork

art direction: Artemio Croatto

art work: Erika Pittis / Designwork

Photography:

Massimo Gardone /Azimut

Printed in Italy

Grafiche GFP

foscarini.com



**FOSCARINI**